

The first name in Italian sofas

the modern collection leather

01
2013

alberta®



The first name in Italian sofas



the modern collection Leather 01

La **modern collection leather** accoglie ed esprime le più concrete ed attuali istanze del vivere lo spazio abitativo. Al di là della qualità che è un valore assoluto e dato per scontato, le parole chiave di questa collezione sono: design dalle linee pure, innovativo ed originale, personalizzazione attraverso una vera libertà di scelta ed interpretazione, garanzia di piacevolezza sensoriale e di comfort. Apriamo così il nostro ventaglio di soluzioni. Ed ognuno ci vedrà il proprio mondo.

The **modern collection leather** embraces and expresses the most genuine, topical aspirations in modern interior décor. Along with quality, which is an absolute, foregone value, the key features of this collection are: innovative, original designs with clean lines; customisation assured by real freedom of choice and interpretation; guaranteed visual and physical comfort and pleasure. We open our treasure chest of solutions. Everyone will find their own world inside it.

La **modern collection leather** accueille et exprime les exigences les plus concrètes et actuelles de la manière de vivre la maison aujourd'hui. Au-delà de la qualité qui est une valeur absolue et qui va de soi, les mots clé de cette collection sont: design aux lignes pures, innovation et originalité, personnalisation à travers une vraie liberté de choix et d'interprétation, garantie de plaisir sensoriel et de confort. Ouvrons donc notre éventail de solutions. Et chacun y verra son propre monde.

Modern collection leather ist eine Sammlung und ein Ausdruck für die konkreten und überaus aktuellen Ansprüche, die an modernen Wohnkomfort gestellt werden. Abgesehen von Qualität, die einen absoluten Wert darstellt und als selbstverständlich vorausgesetzt wird, sind die wesentlichen Merkmale dieser Kollektion: Design mit klaren, innovativen und originellen Linien, individuelle Gestaltung durch vielfältige Auswahl und Möglichkeiten der Interpretation, angenehme sinnliche Empfindungen und Komfort. So öffnen wir das breite Spektrum unserer Lösungen. Eine eigene Welt für jeden.

alberta®

| | |
|---------------|-----|
| AVENUE | 6 |
| BLOW | 14 |
| BROADWAY | 30 |
| CALIFORNIA | 38 |
| CHORUS | 44 |
| DALLAS | 50 |
| LUNA | 58 |
| MANHATTAN | 64 |
| NEWPORT | 74 |
| RALPH | 84 |
| RIVER | 92 |
| STELLA_MOON | 100 |
| SUMMER | 112 |
| WILD | 122 |
| KALINDA | 132 |
| ARCADIA | 140 |
| CHEOPE SQUARE | 146 |
| CHESTER | 152 |
| POUFF | 158 |
| CUSCINI | 170 |

| | |
|--|-----|
| Disegni tecnici / <i>technical drawings</i> | 176 |
| Descrizione tecniche / <i>technical descriptions</i> | 198 |
| COMPANY PROFILE | 204 |



AVENUE



2AVPD3 _ pelle, leather, cuir, Leder: 954 Fjord, cat. G

alberta the modern collection Leather _ 7

AVENUE



0AVPC2 _ pelle, leather, cuir, Leder: 954 Fjord, cat. G

alberta the modern collection Leather _ 9



AVENUE



Poggiatesta regolabili, adjustable headrests



0AVPC2 _ pelle, leather, cuir, Leder: 500 Sahara, cat. E
braccioli stretti, thin armrests, accoudoirs étroits, Engen Armlehnen

BLOW

*sintesi assoluta tra
innovazione e armonia delle forme*

*absolute fusion between
innovation and harmony of shapes*



BLOW



2BLWD3MSPBSAD _ pelle, leather, cuir, Leder: 500 Sahara, cat. E
alberta the modern collection Leather _ 17

BLOW



B

2BLWD3MB _ pelle, leather, cuir, Leder: 500 Sahara, cat. E



A

2BLWD3MA _ pelle, leather, cuir, Leder: 500 Sahara, cat. E

BLOW



2BLWCHLSXA - 2BLWPFF - 2BLWCHLDXA
pelle, leather, cuir, Leder: 960 Feeling, cat. G
alberta the modern collection Leather _ 21



2BLWD3DXA - 1BLWPFF - 2BLWD2SXA
pelle, leather, cuir, Leder: 526 Sahara, cat. E
alberta the modern collection Leather _ 23

BLOW



0BLWC4 _ pelle, leather, cuir, Leder: 960 Feeling, cat. G

alberta the modern collection Leather _ 25

BLOW



0BLWC1 - 2BLWCL - 2BLWCL
pelle, leather, cuir, Leder: 8A1 Capital, cat. G





2BLWPB _ pelle, leather, cuir, Leder: 500 Sahara, cat. E



BLOW

2BLWBG - 2BLWPFSSM
pelle, leather, cuir, Leder: 9C4 Sensation, cat. H

BROADWAY

*linee eleganti
per rilassarsi con stile*

*elegant lines
to get relaxed in style*





BROADWAY



C6PBDP _ pelle, leather, cuir, Leder: 518 Sahara, cat. E

alberta the modern collection Leather _ 33

BROADWAY



BROADWAY



C1PBDP _ pelle, leather, cuir, Leder: 8B1 Price, cat. F
alberta the modern collection Leather _ 37

CALIFORNIA

*cura dei particolari
per un comfort di pura eleganza*

*the greatest care
for details to achieve a pure stylish comfort*





CALIFORNIA



0CALC1 _ pelle, leather, cuir, Leder: 500 Sahara, cat. E
Braccioli stretti, thin armrests, accoudoirs étroits, Engen Armlehnen

CHORUS

ricercato stile informale
sophisticated informal style





CHORUS



2CHOD3 - 1CHOPTD3
pelle, leather, cuir, Leder: 500 Sahara, cat. E
alberta the modern collection Leather _ 49

DALLAS

*impeccabile perfezione
delle linee*

*immaculate perfection
of shapes*



DALLAS



DALLAS





LUNA

*dal design essenziale,
una bellezza raffinata*

*essential design,
refined beauty*





0LUNC1 _ pelle, leather, cuir, Leder: 500 Sahara, cat. E

LUNA



MANHATTAN

*contemporaneità delle
proporzioni e dettagli unici*

*contemporary shapes
and unique details*





MANHATTAN



D3MPMAN - PCENJPMAT
pelle, leather, cuir, Leder: 960 Feeling, cat. G
alberta the modern collection Leather _ 69

MANHATTAN



MANHATTAN



C3PMAT _ pelle, leather, cuir, Leder: 942 Fjord, cat. G
alberta the modern collection Leather _ 73

NEWPORT

comfort unico e originale
unusual and original comfort





C13PNWP _ pelle, leather, cuir, Leder: 960 Feeling, cat. G



NEWPORT





RALPH

*artigianalità e tecnologia
per un irrinunciabile relax*

*solid fusion between
craftsmanship and technology
for a unique relax*



RALPH



ORALC4 - RALCQ45P
pelle, leather, cuir, Leder: 8B1 Price, cat. F
alberta the modern collection Leather _ 87

RALPH



ORALC3 _ pelle, leather, cuir, Leder: 500 Sahara, cat. E

alberta the modern collection Leather _ 89



RIVER

*ricercatezza e sinuosità
delle linee*

*flexuous and elegant
silhouette*



RIVER



ORIVC2 _ pelle, leather, cuir, Leder: 500 Sahara, cat. E

alberta the modern collection Leather _ 95



2RIVANGSCDX - 2RIVPFFRG SX _ pelle, leather, cuir, Leder: 500 Sahara, cat. E
3 1RITSC70 _ tessuto, fabric, tissu, Stoff: 521S Mina bianco - 521R Mina nero, cat. 5

RIVER



ORIVC3 - 2RIVPGR - 2RIVPFOC
pelle, leather, cuir, Leder: 500 Sahara, cat. E

STELLA_MOON

*lavorazioni da bottega artigiana
crafted as in an artisanal workshop*







OSTPC2 _ pelle, leather, cuir, Leder: 954 Fjord, cat. G

alberta the modern collection Leather _ 105



STELLA



MOON





MOON

SUMMER

*comodità e comfort
non convenzionali*

unconventional comfort



SUMMER



SUMMER



SUMMER



SUMMER



WILD

*particolari unici
finemente studiati*

*unique details
finely designed*



WILD



WILD



2WILD3 - 2WILPT75
pelle, leather, cuir, Leder: 946 Fjord, cat. G

126



alberta the modern collection Leather _ 127

WILD



2WILPM _ pelle, leather, cuir, Leder: 954 Fjord, cat. G



2WILPS _ pelle, leather, cuir, Leder: 946 Fjord, cat. G



2WILP _ pelle, leather, cuir, Leder: 954 Fjord, cat. G

WILD



KALINDA

*decisa personalità
per un'eleganza intramontabile*

*a strong personality
for a timeless elegance*





C1PKLD _ pelle, leather, cuir, Leder: 960 Feeling, cat. G



KALINDA



KALINDA



CHLPKLD _ pelle, leather, cuir, Leder: 8A1 Capital, cat. F
PTKLT _ tessuto, fabric, tissu, Stoff: 404Q Kendall argento, cat. 4

alberta the modern collection Leather _ 139

ARCADIA

*preziose finiture
vestono momenti speciali*

*precious features
exalt special moments*

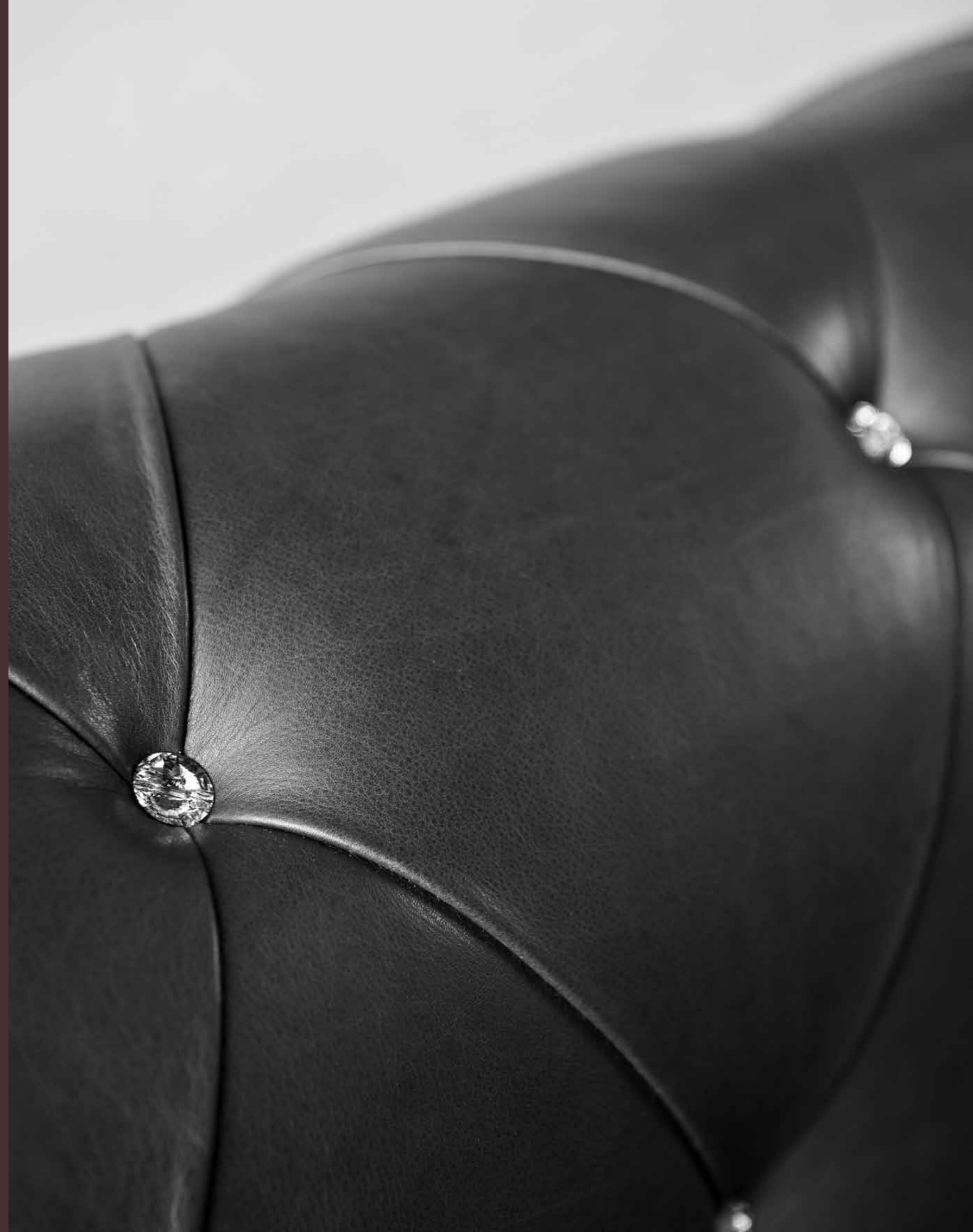



D2MSPARD - POUFFSPARD - 2NORP - 2NORP
pelle, leather, cuir, Leder: 526 Sahara, cat. E
albarta the modern collection Leather _ 143



ARCADIA

CHEOPE SQUARE

*espressione
di raffinato glamour*

*expression
of elegant glamour*





CHEOPE SQUARE



CHESTER

*eleganza assoluta nell'esprimere
il senso profondo di casa*

*absolute elegance reveals
the deep sense of home*





D33PCHR - PSPCHR - PSPCHR
pelle, leather, cuir, Leder: 962 Feeling, cat. G

CHESTER

D3PCHR - PPCHR - PNCPCHR - POUFFOSPARD
pelle, leather, cuir, Leder: 968 Forest, cat. G



POUFF

*libere interpretazioni ed espressioni
del gusto personale*

*the freedom to interpret and express your
own personal taste*





MORBIDOSO_99





MORBIDOSO_99_BABY



MORBIDOSO_99



CUSCINI

*atmosfera di luminosa modernità
illuminating, modern ambiances*





CUSCINI





Disegni tecnici
technical drawings

alberta[®]

THE MODERN COLLECTION LEATHER AVENUE



COMPOSIZIONI / COMPOSITIONS / COMPOSITIONS / KOMPOSITIONEN

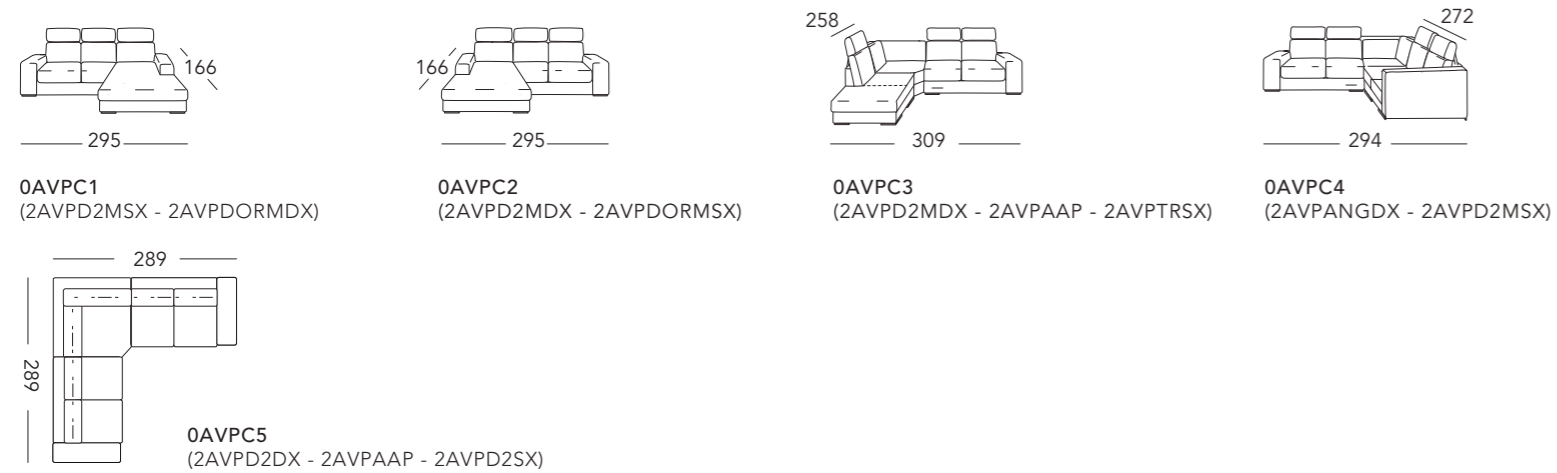

ELEMENTI / ELEMENTS / ELEMENTS / ELEMENTE

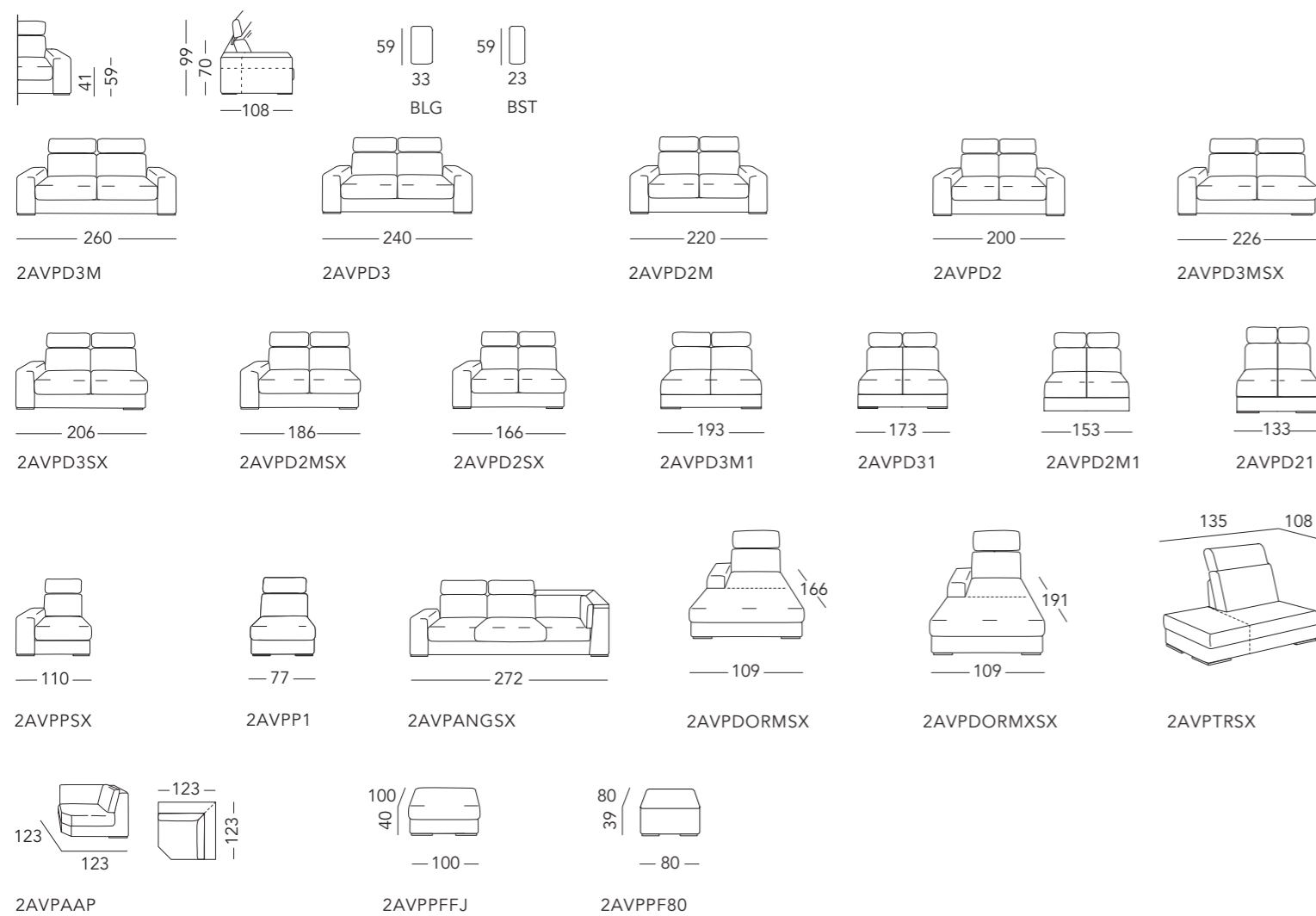

COMPOSIZIONI / COMPOSITIONS / COMPOSITIONS / KOMPOSITIONEN

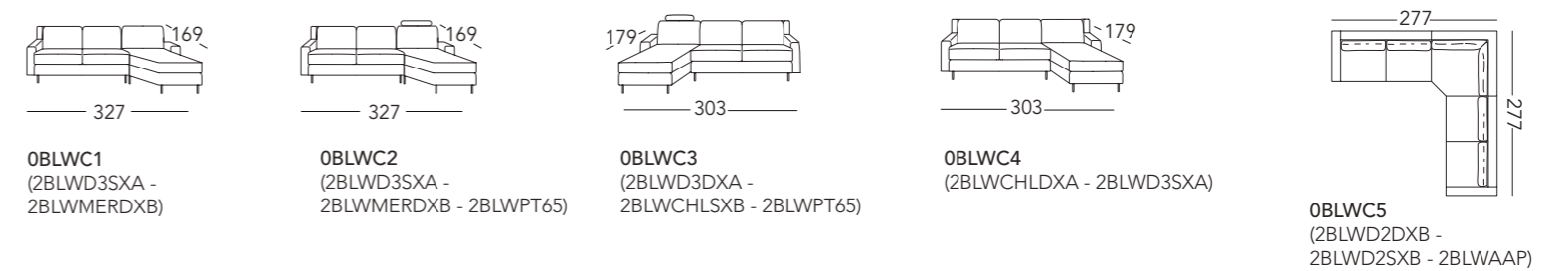

ELEMENTI / ELEMENTS / ELEMENTS / ELEMENTE

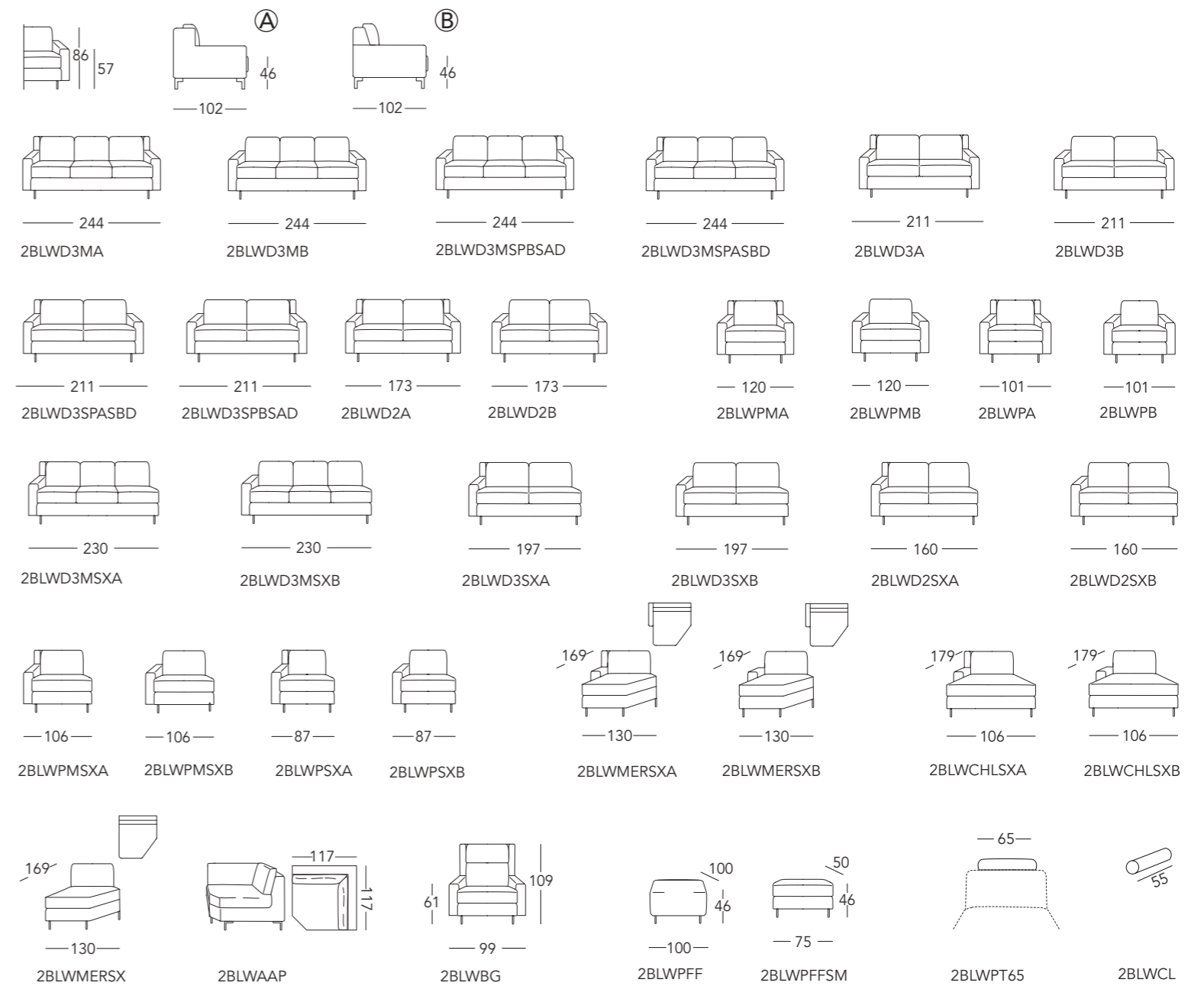

THE MODERN COLLECTION LEATHER

BROADWAY



THE MODERN COLLECTION LEATHER

COMPOSIZIONI / COMPOSITIONS / COMPOSITIONS / KOMPOSITIONEN

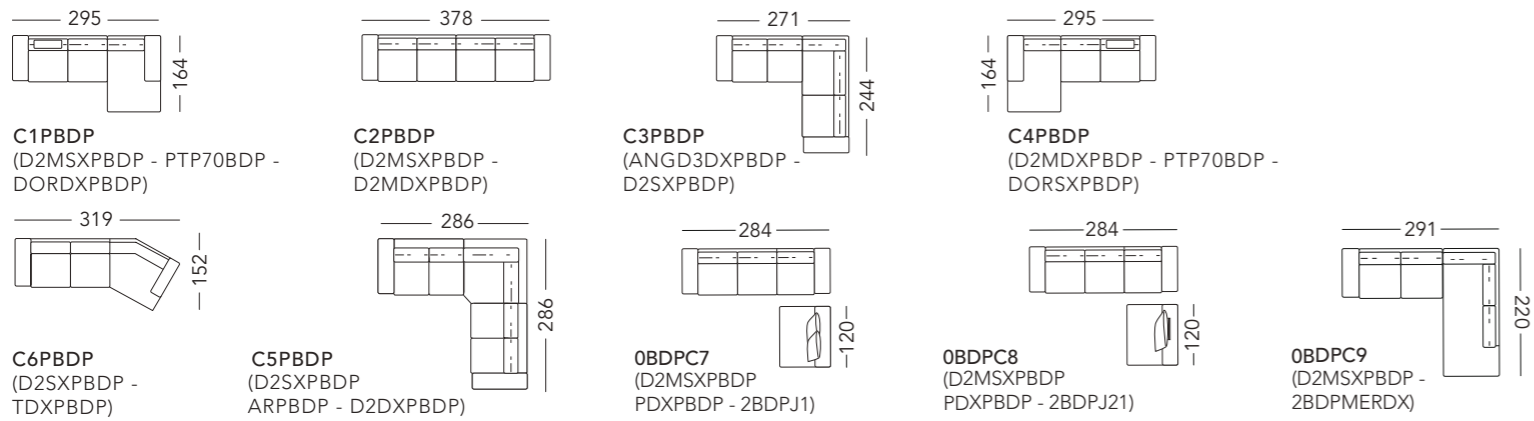

ELEMENTI / ELEMENTS / ELEMENTS / ELEMENTE

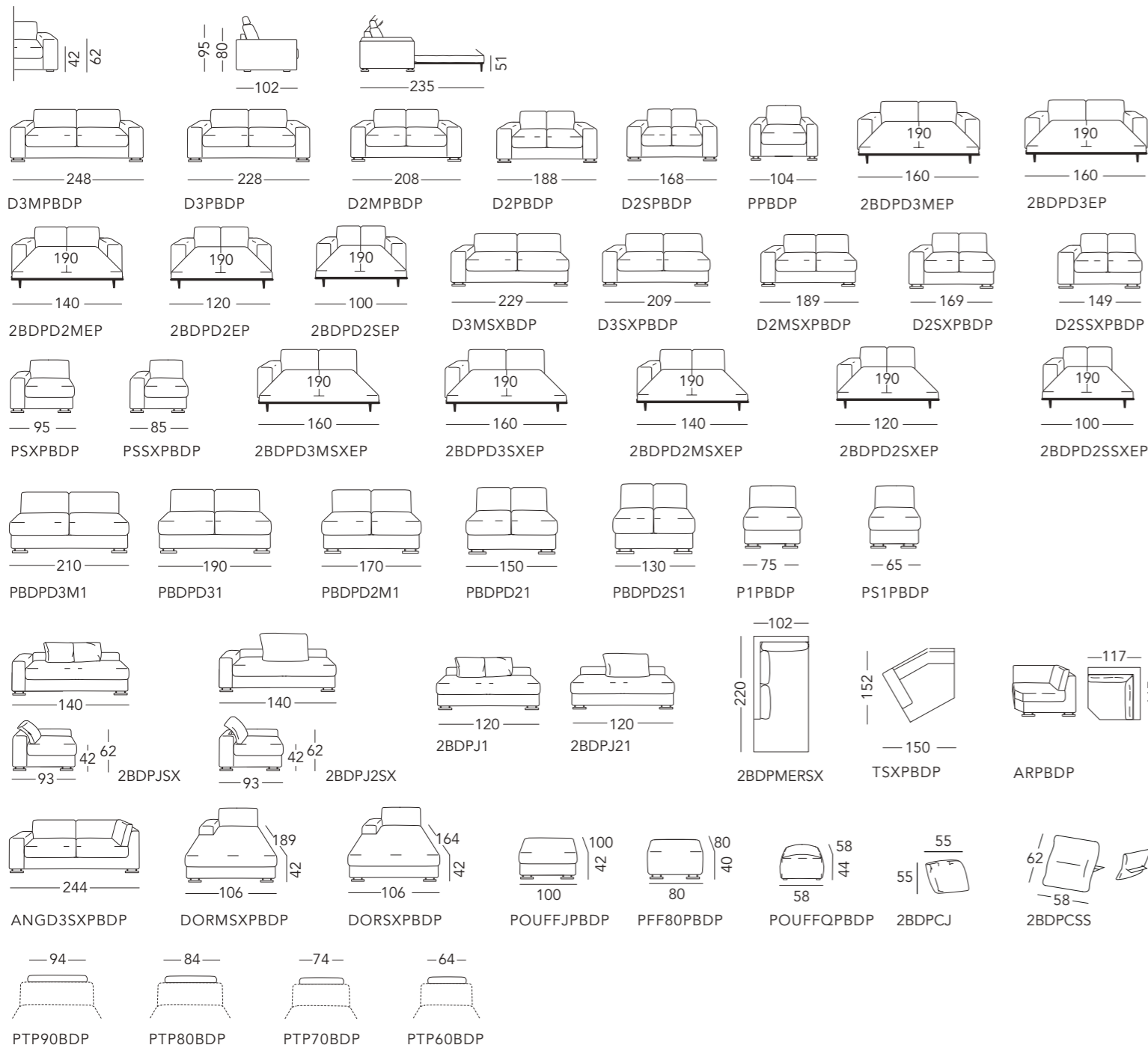

COMPOSIZIONI / COMPOSITIONS / COMPOSITIONS / KOMPOSITIONEN

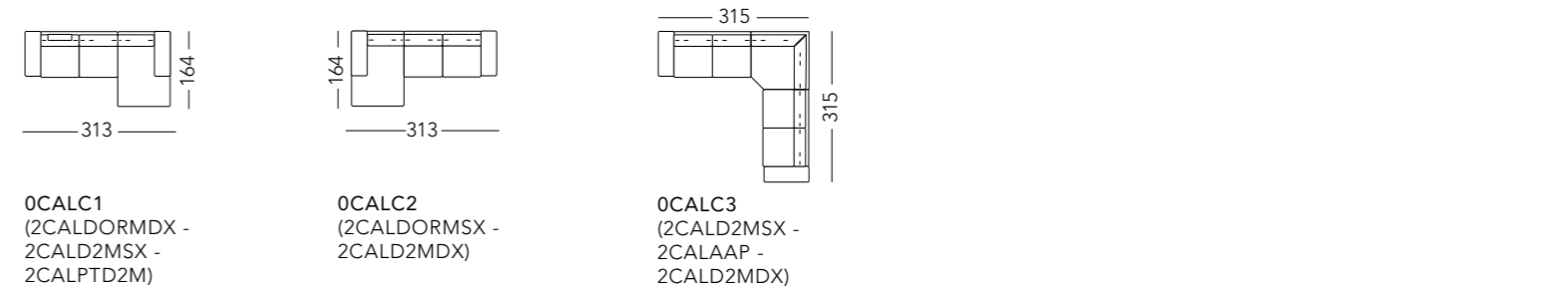

ELEMENTI / ELEMENTS / ELEMENTS / ELEMENTE

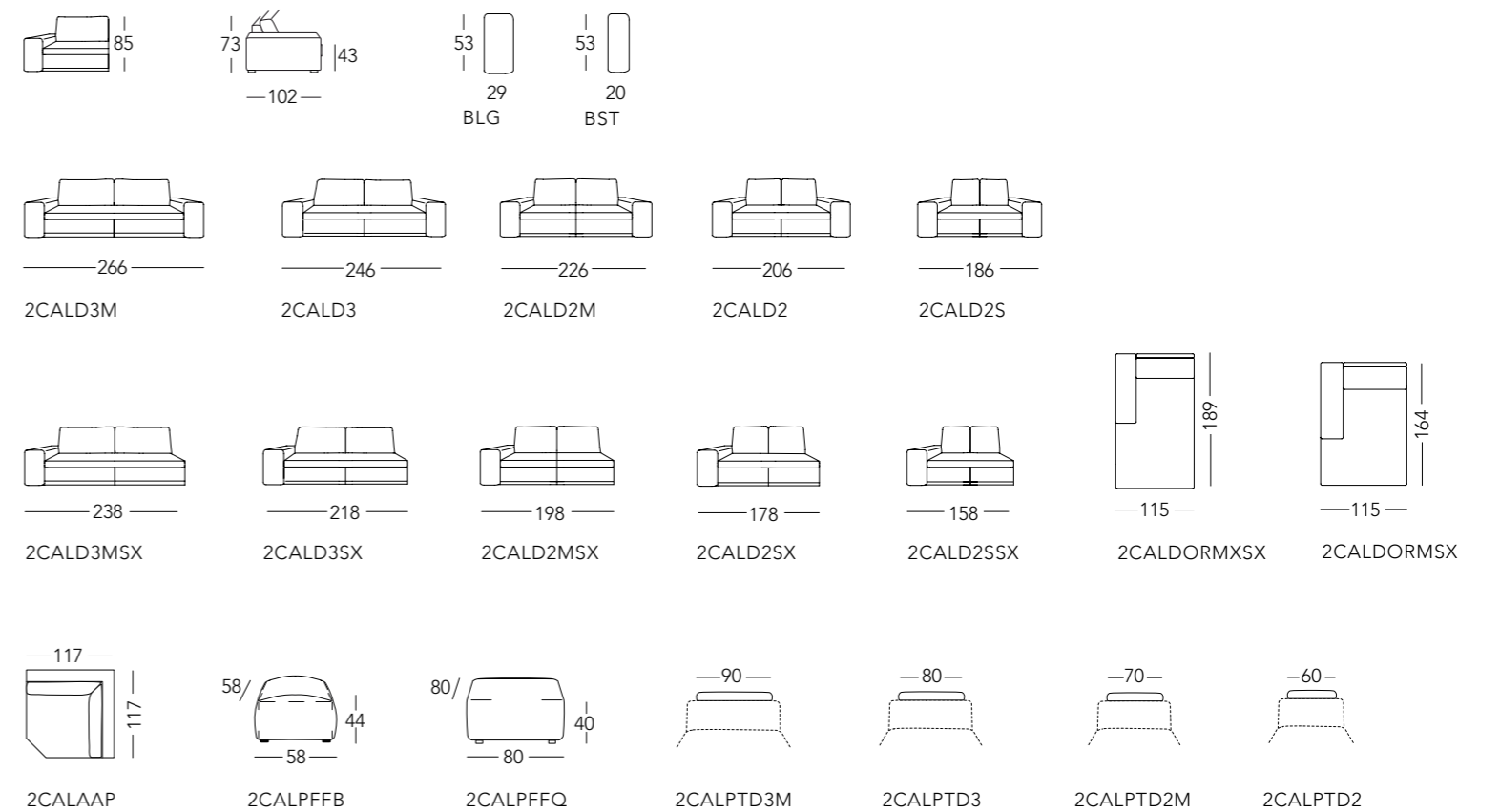

THE MODERN COLLECTION LEATHER

CHORUS



THE MODERN COLLECTION LEATHER

COMPOSIZIONI / COMPOSITIONS / COMPOSITIONS / KOMPOSITIONEN

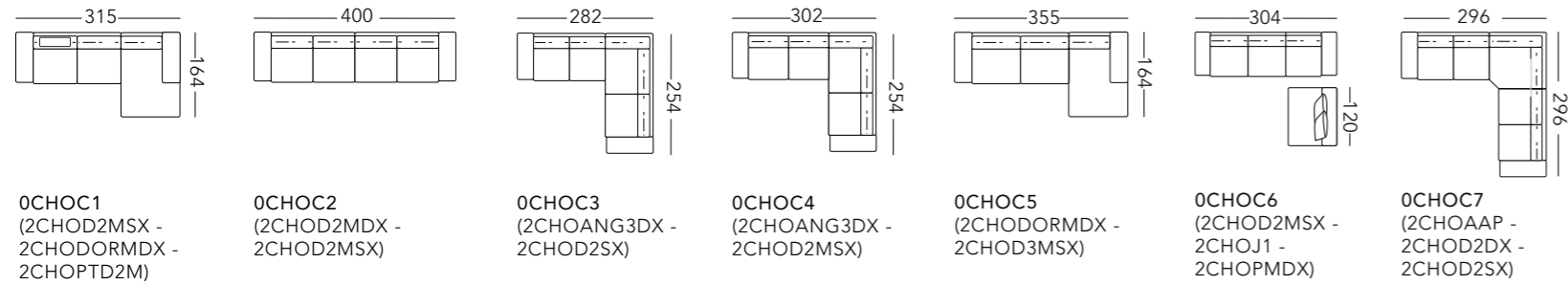

ELEMENTI / ELEMENTS / ELEMENTS / ELEMENTE

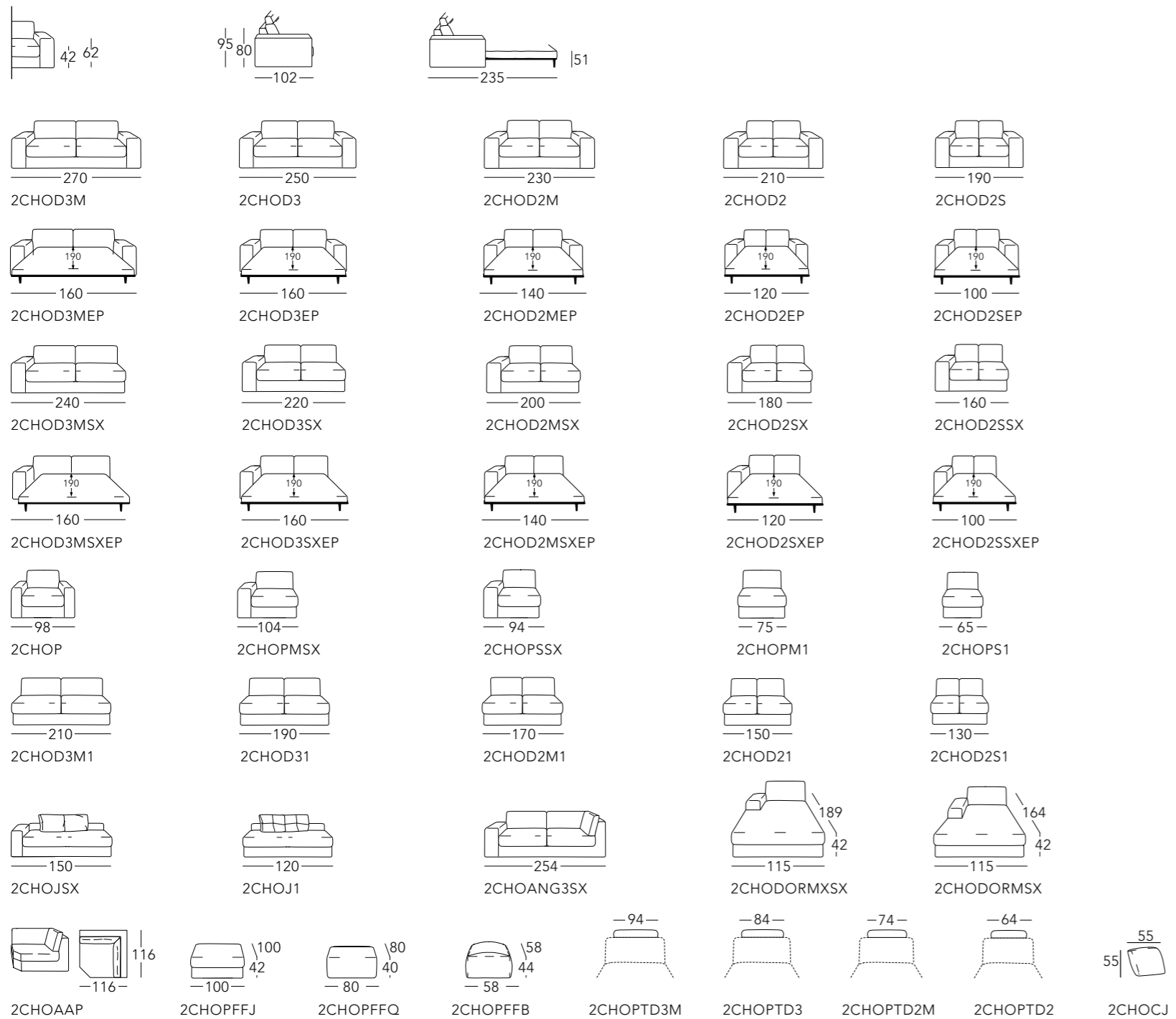

COMPOSIZIONI / COMPOSITIONS / COMPOSITIONS / KOMPOSITIONEN

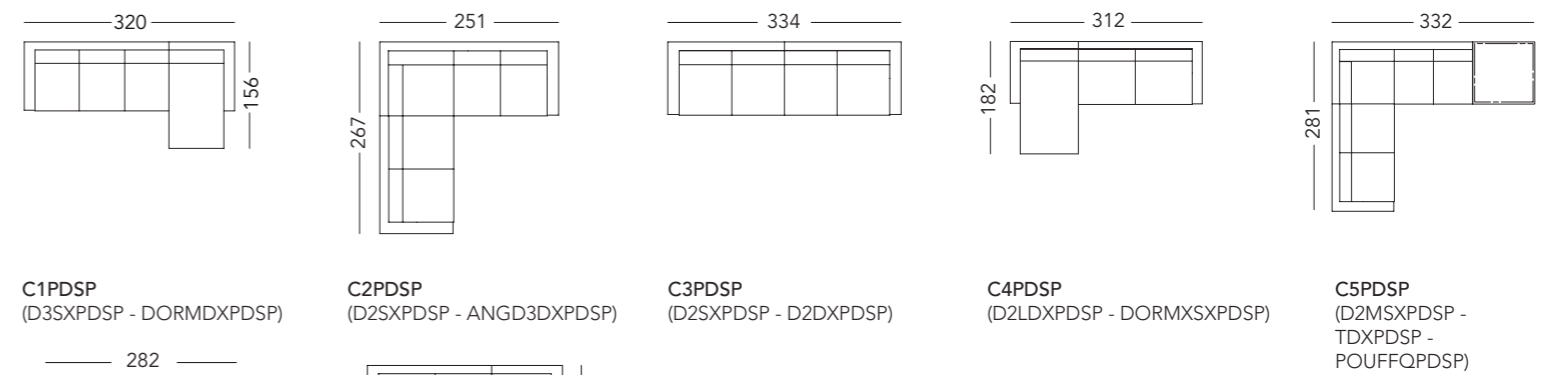

ELEMENTI / ELEMENTS / ELEMENTS / ELEMENTE

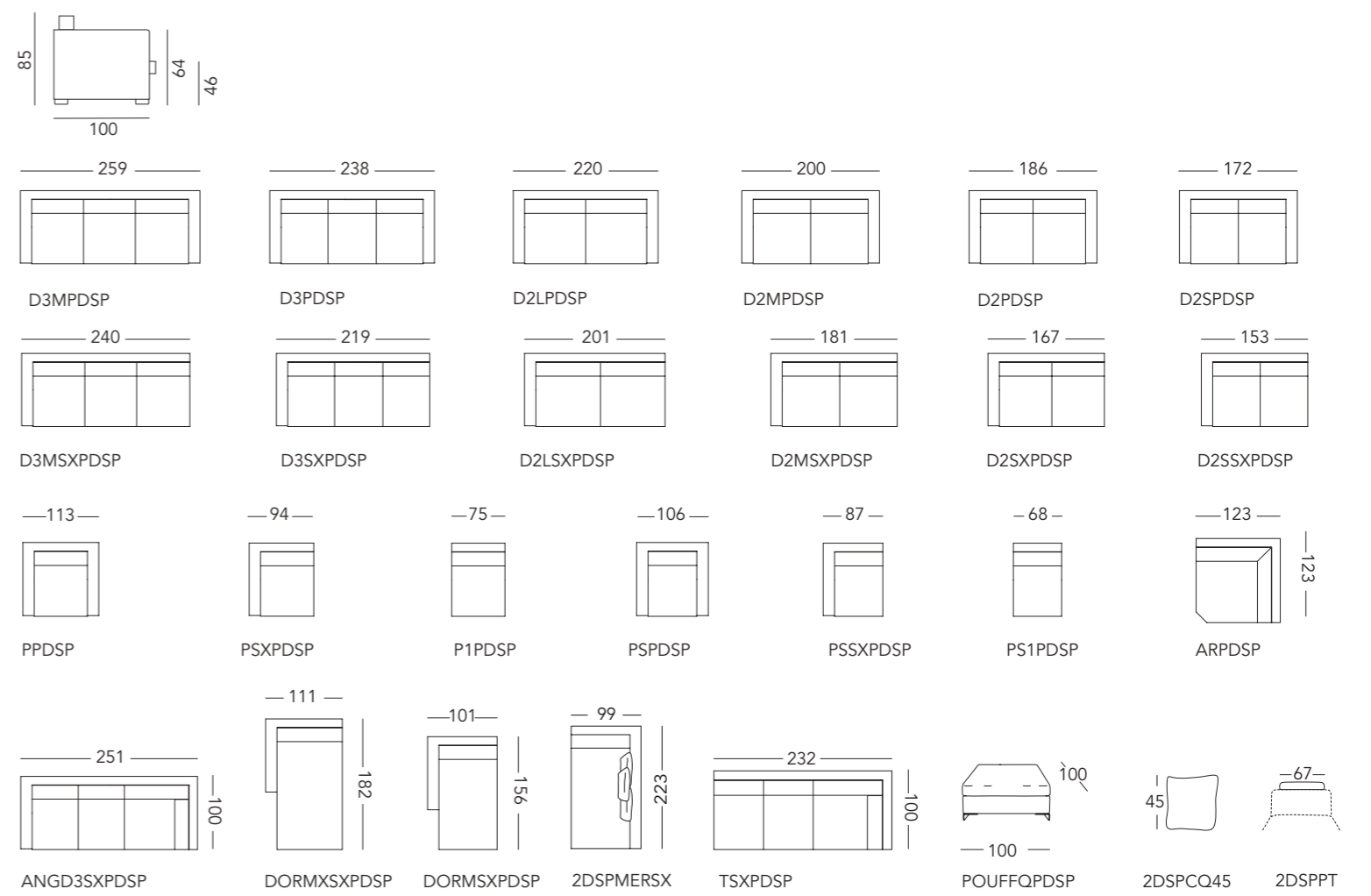

THE MODERN COLLECTION LEATHER

LUNA



THE MODERN COLLECTION LEATHER

COMPOSIZIONI / COMPOSITIONS / COMPOSITIONS / KOMPOSITIONEN

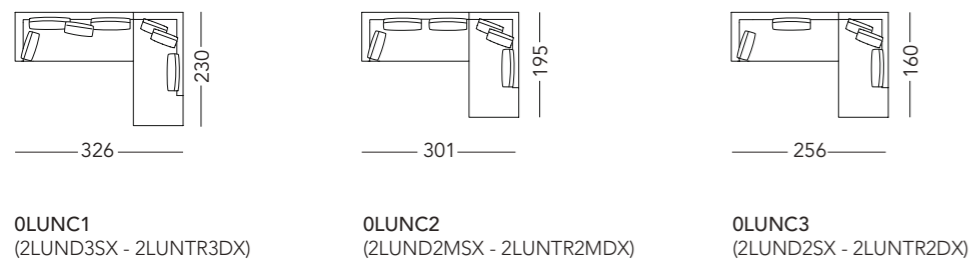

ELEMENTI / ELEMENTS / ELEMENTS / ELEMENTE

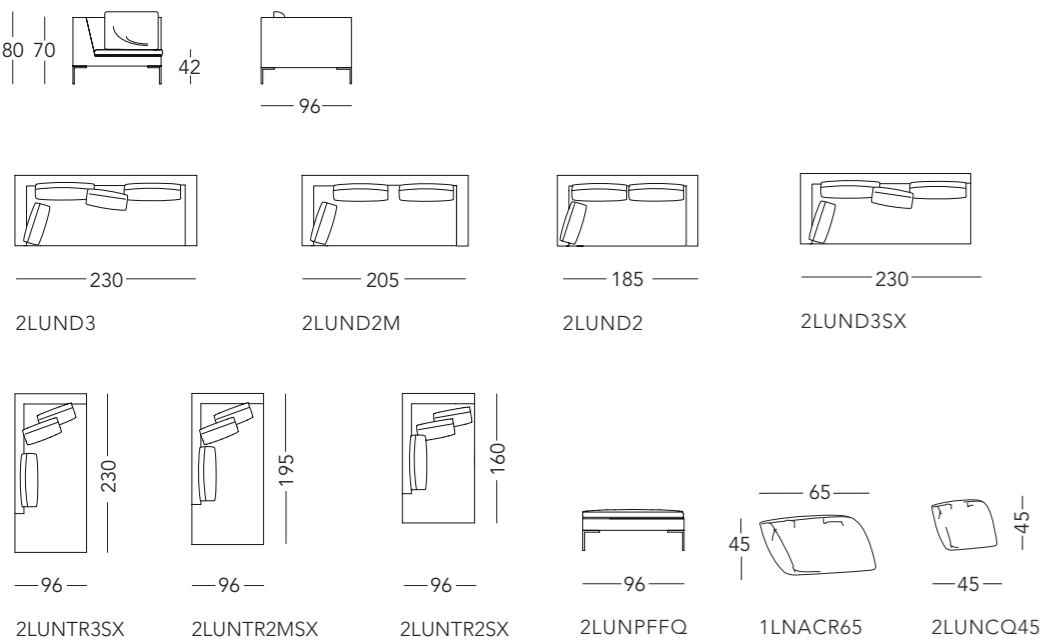

COMPOSIZIONI / COMPOSITIONS / COMPOSITIONS / KOMPOSITIONEN

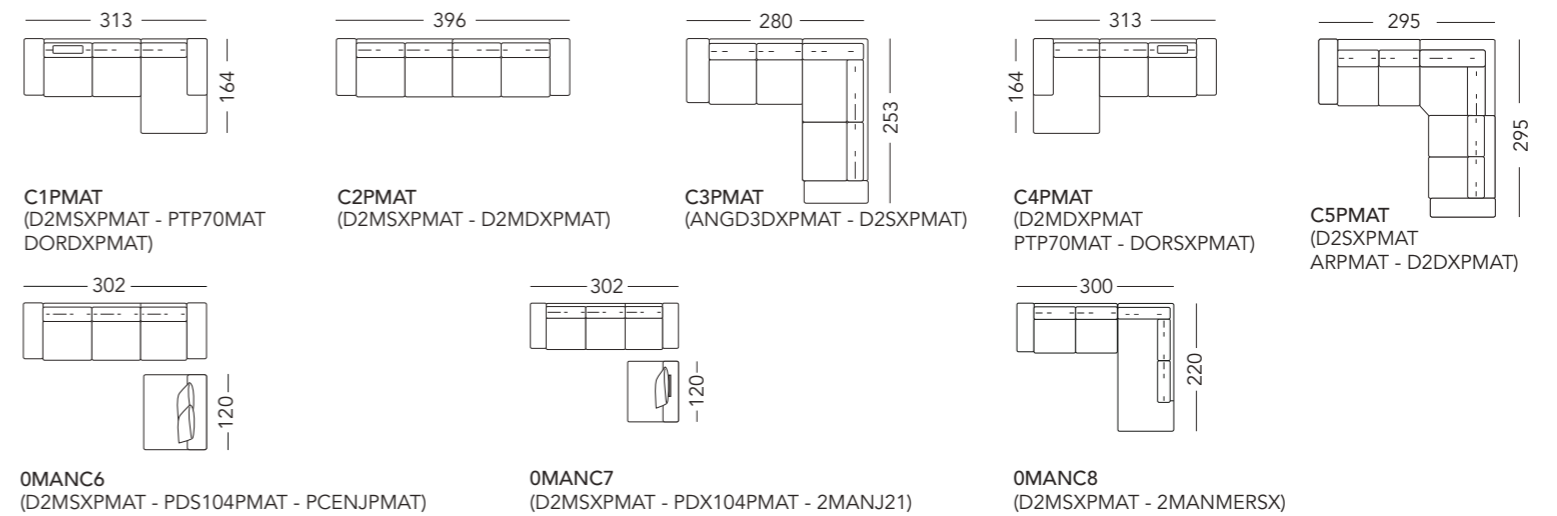

ELEMENTI / ELEMENTS / ELEMENTS / ELEMENTE

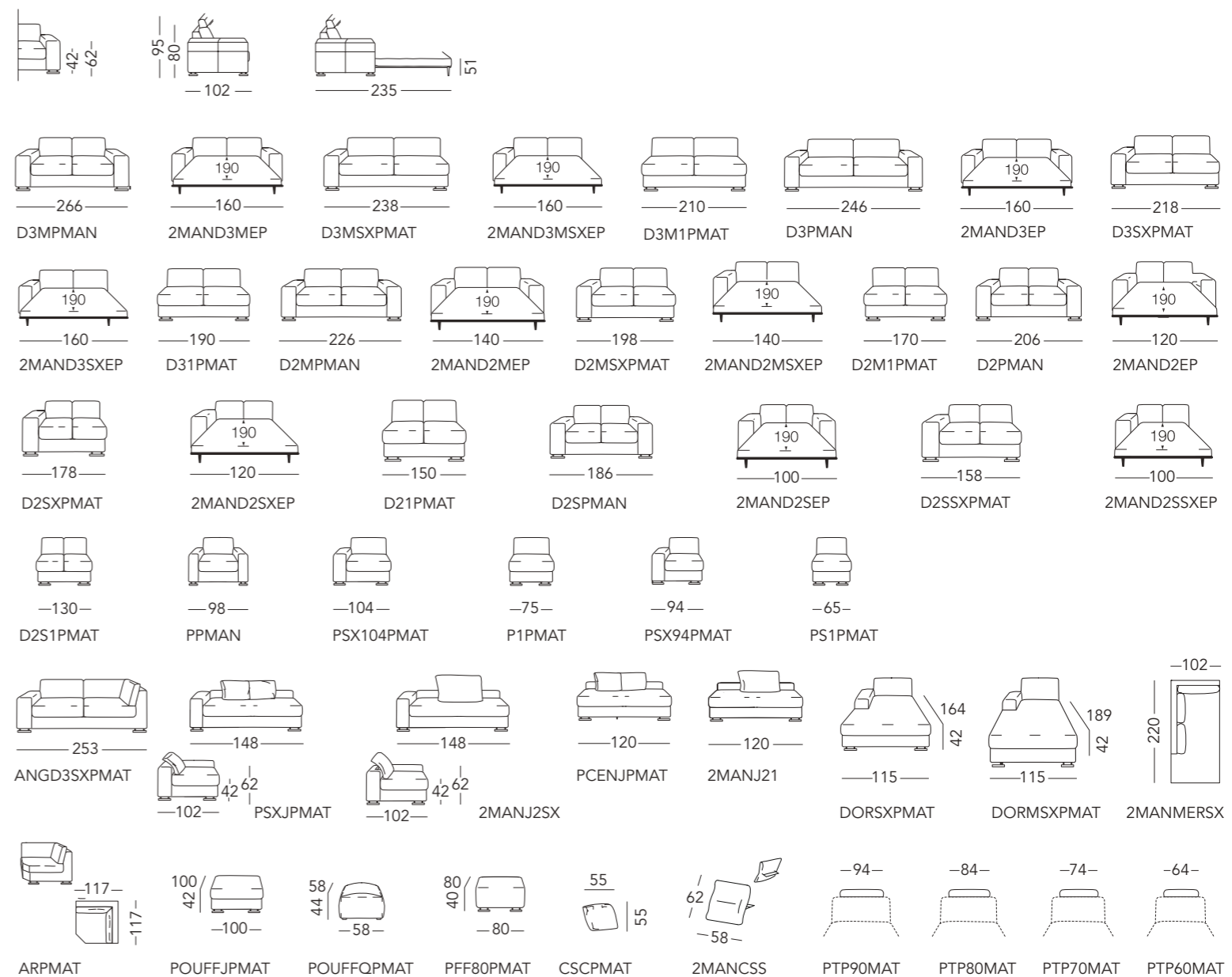

THE MODERN COLLECTION LEATHER NEWPORT



THE MODERN COLLECTION LEATHER

COMPOSIZIONI / COMPOSITIONS / COMPOSITIONS / KOMPOSITIONEN

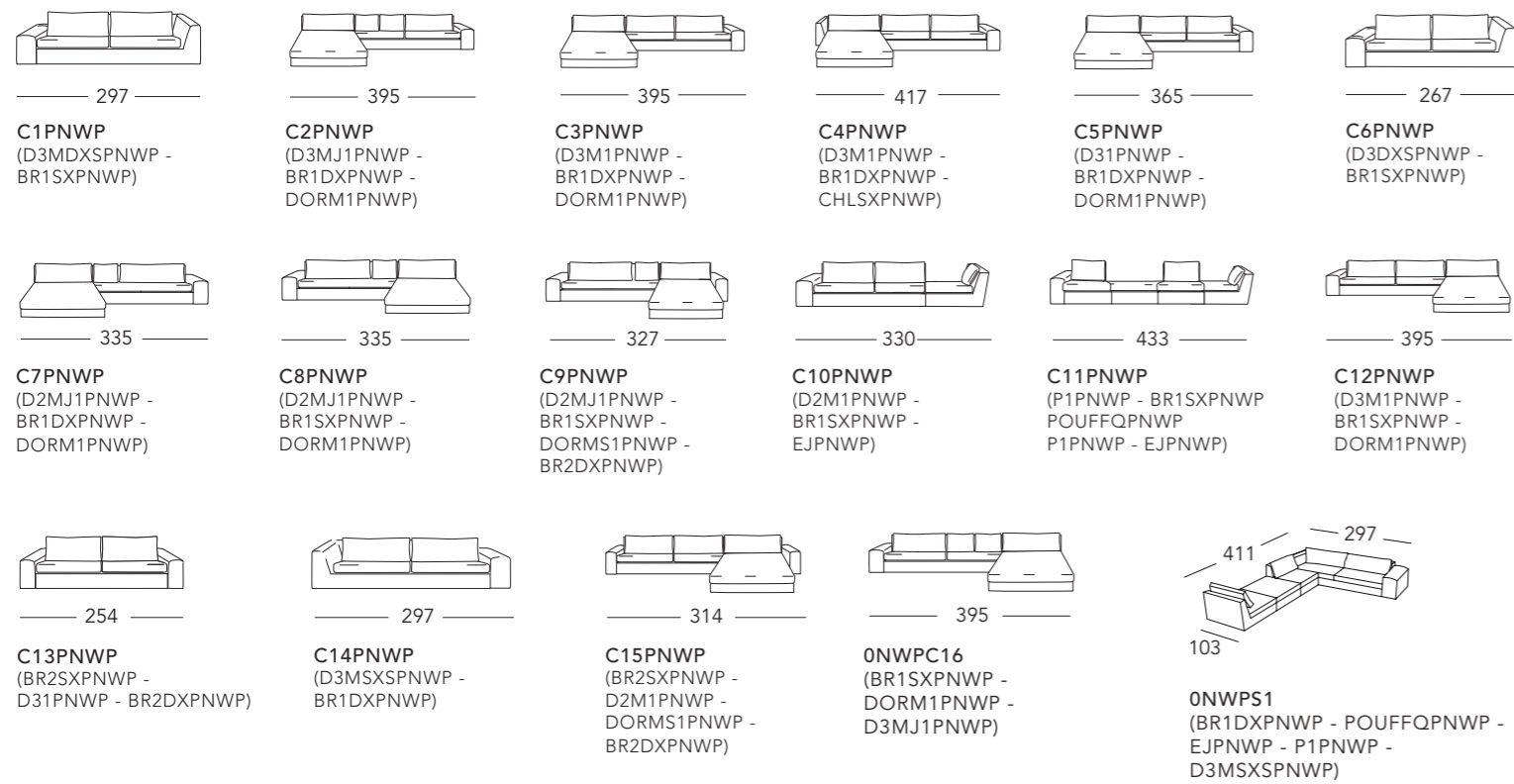

ELEMENTI / ELEMENTS / ELEMENTS / ELEMENTE

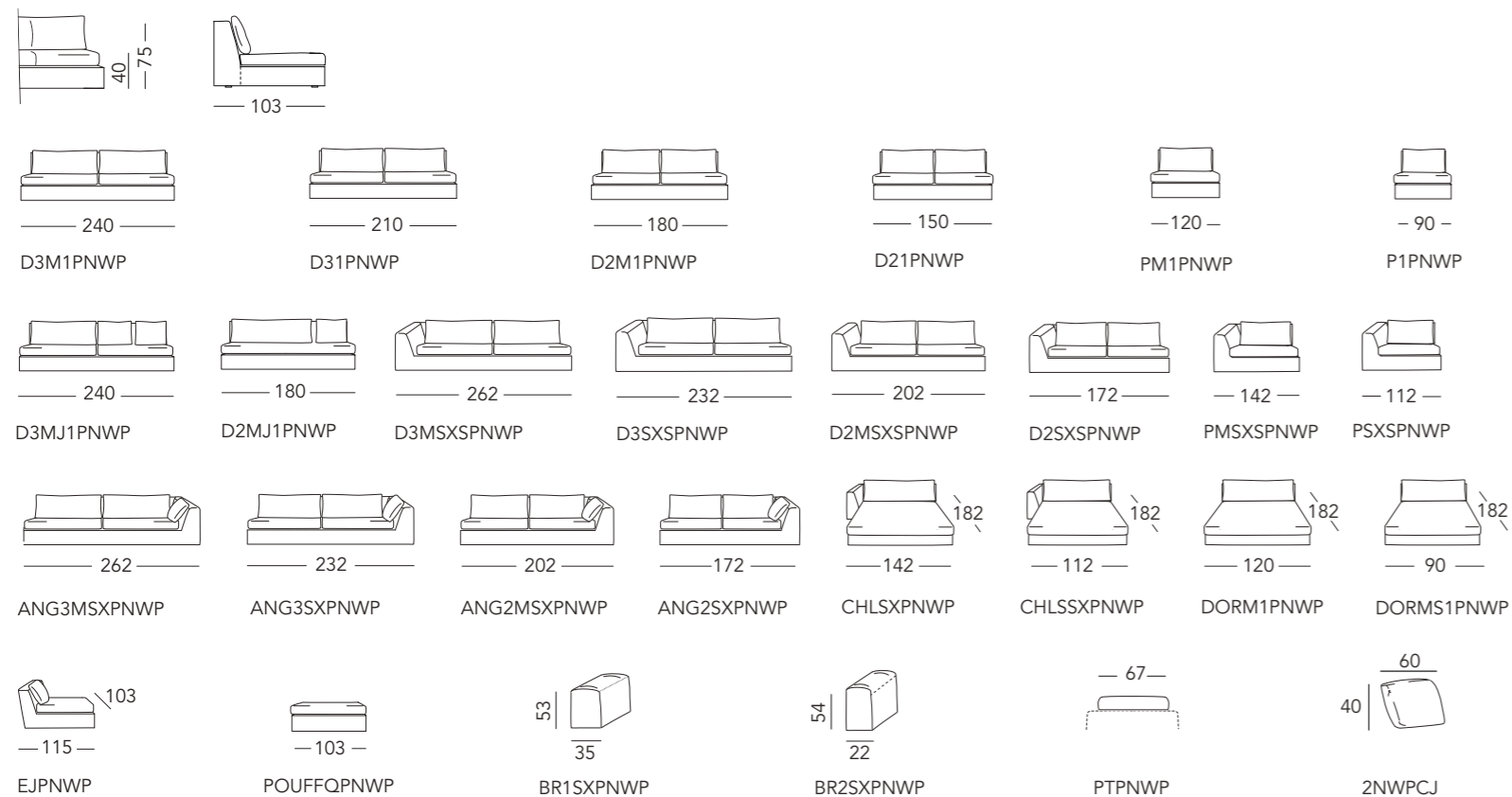

COMPOSIZIONI / COMPOSITIONS / COMPOSITIONS / KOMPOSITIONEN

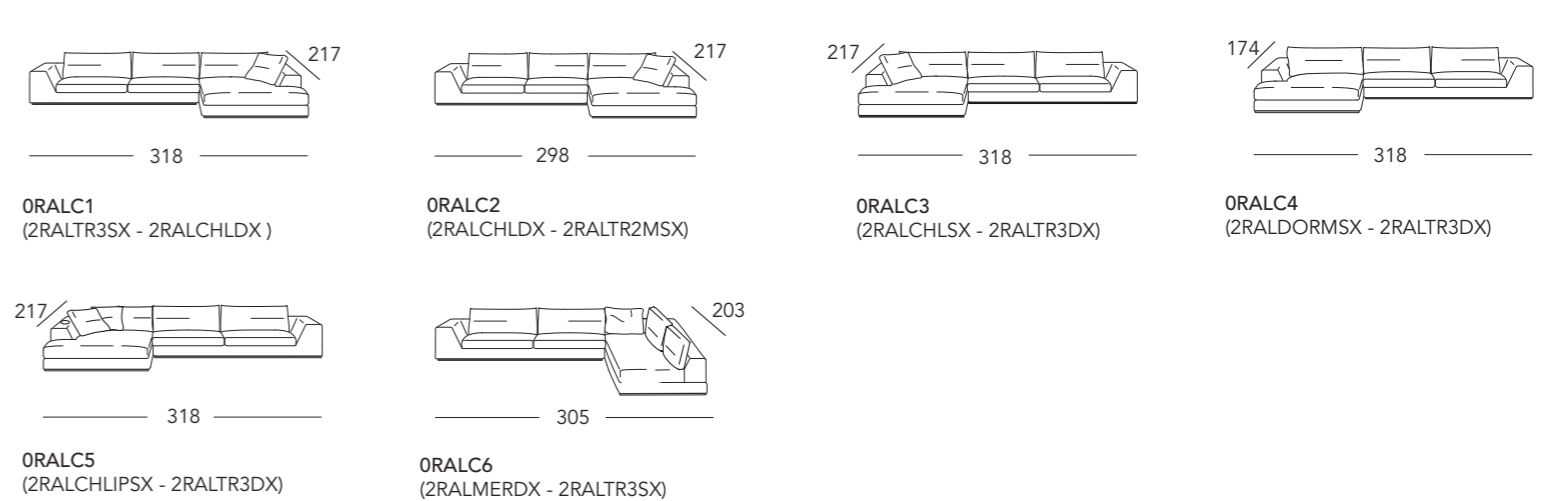

ELEMENTI / ELEMENTS / ELEMENTS / ELEMENTE

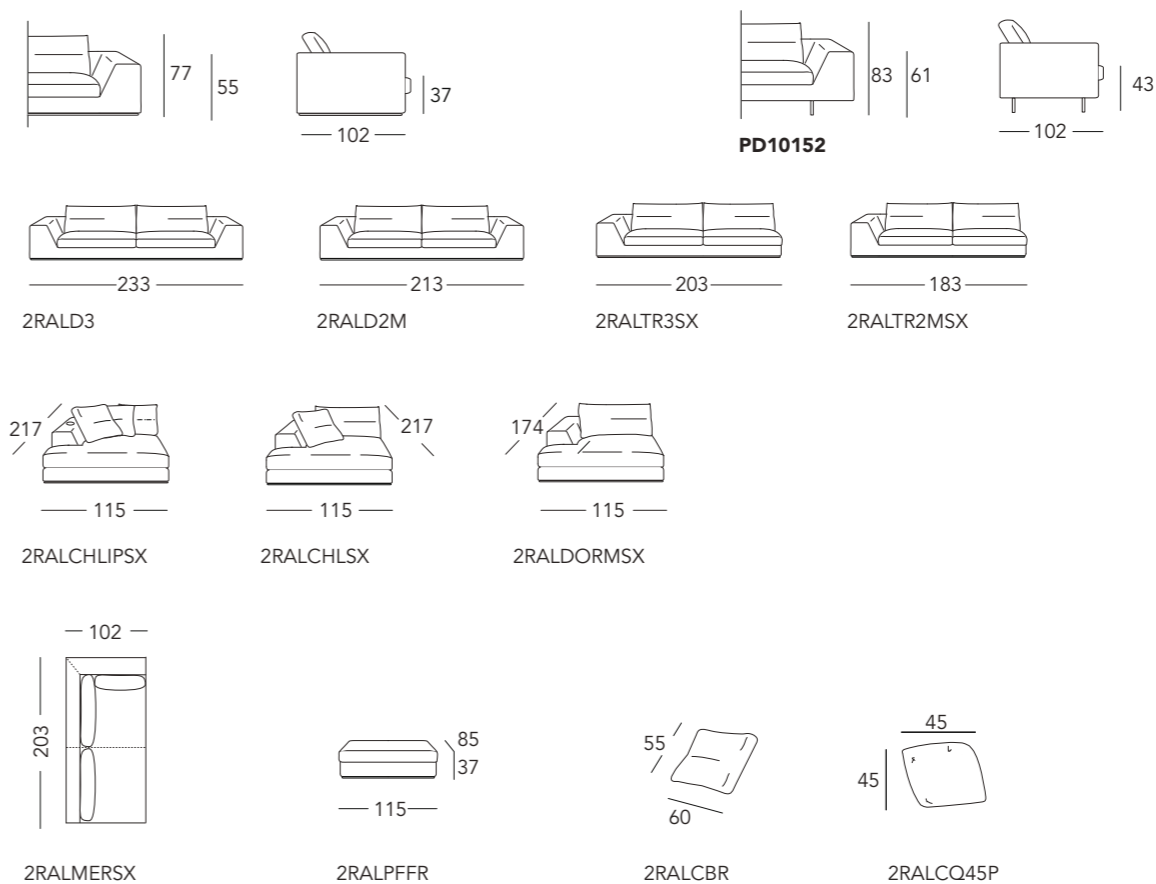

THE MODERN COLLECTION LEATHER RIVER



THE MODERN COLLECTION LEATHER MOON

COMPOSIZIONI / COMPOSITIONS / COMPOSITIONS / KOMPOSITIONEN

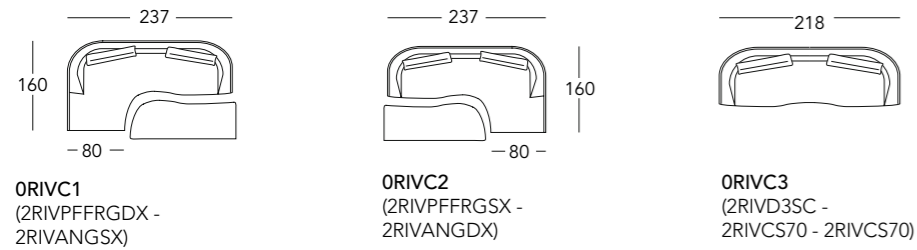

ELEMENTI / ELEMENTS / ELEMENTS / ELEMENTE

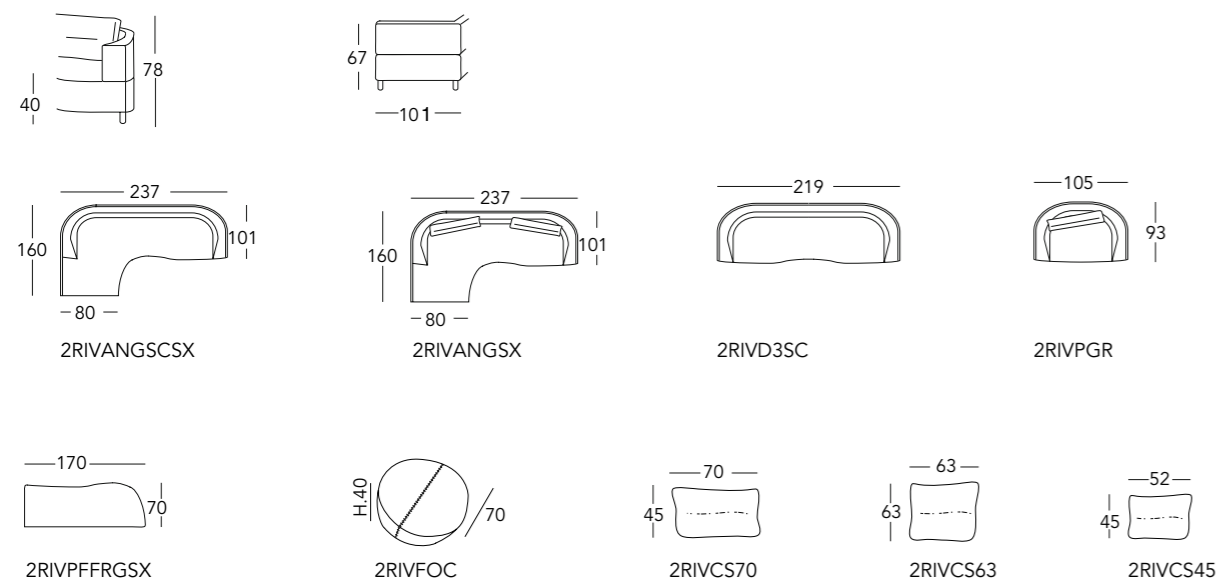

COMPOSIZIONI / COMPOSITIONS / COMPOSITIONS / KOMPOSITIONEN

MOON

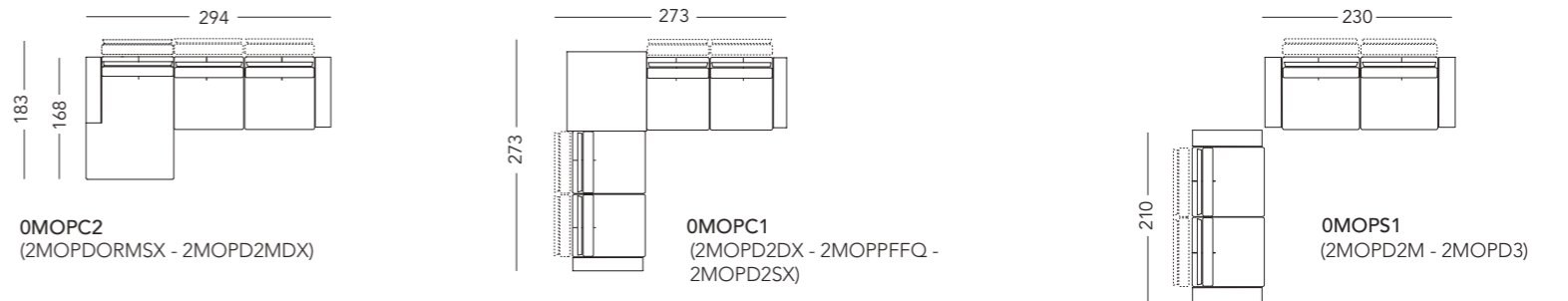

ELEMENTI / ELEMENTS / ELEMENTS / ELEMENTE

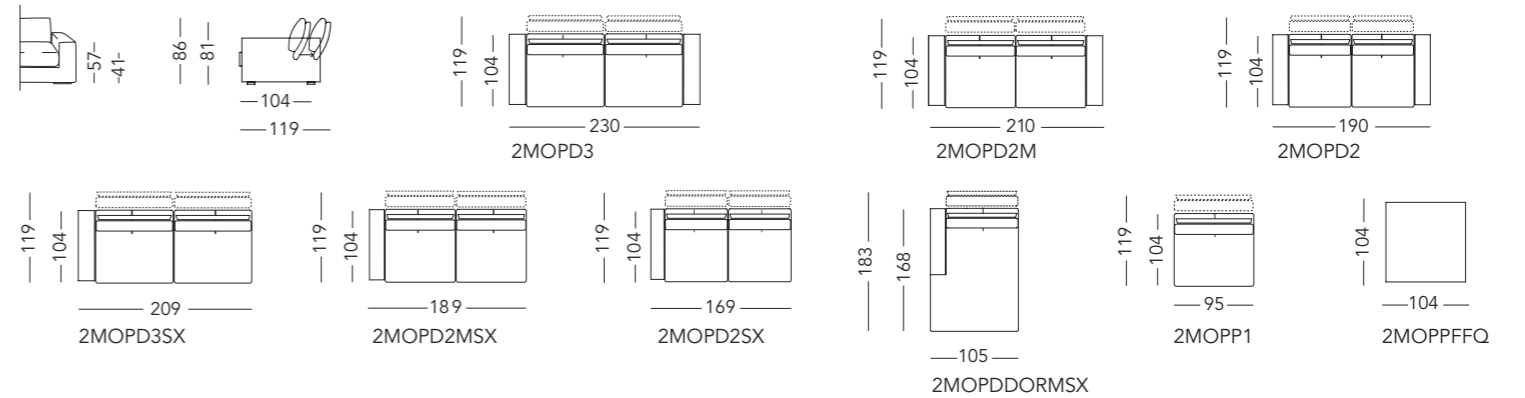

COMPOSIZIONI / COMPOSITIONS / COMPOSITIONS / KOMPOSITIONEN

STELLA

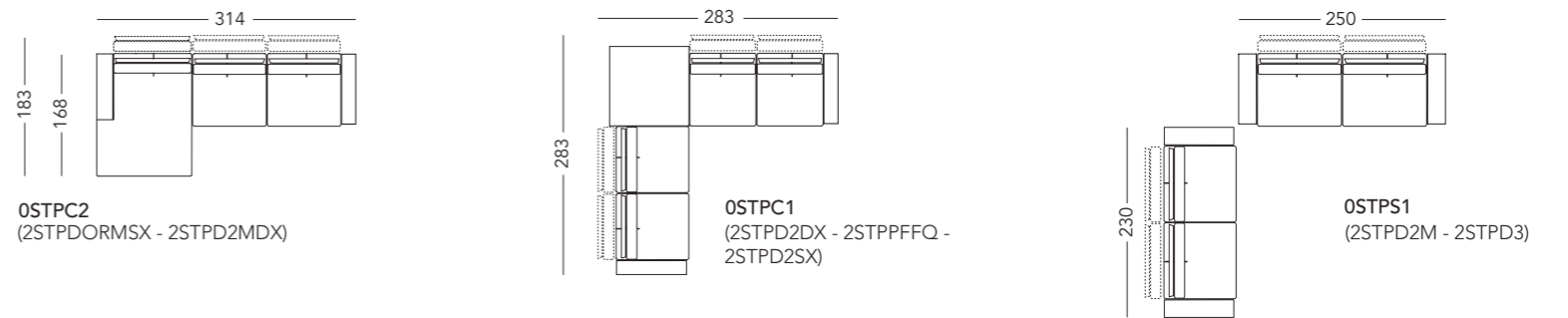

ELEMENTI / ELEMENTS / ELEMENTS / ELEMENTE

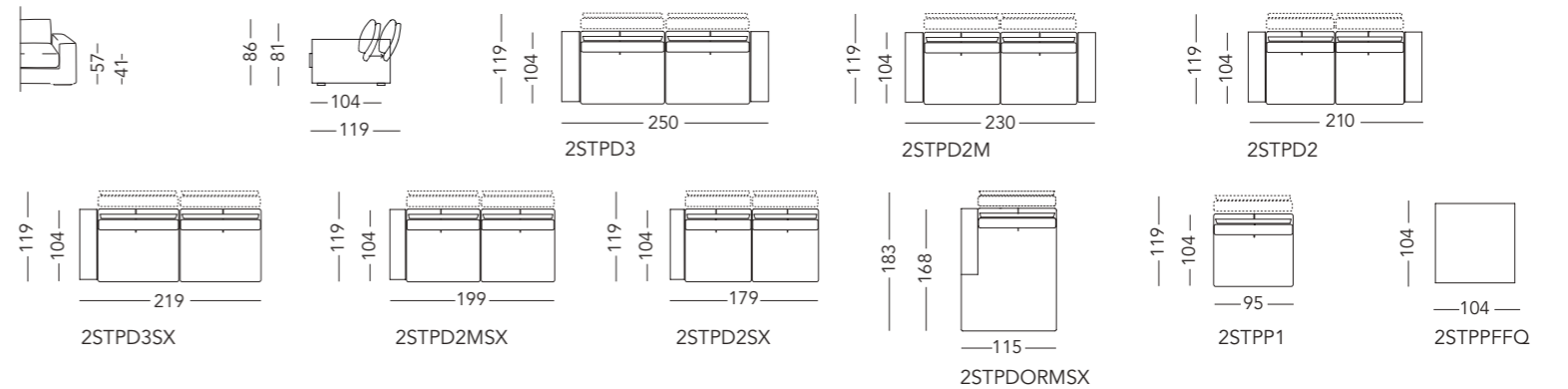

THE MODERN COLLECTION LEATHER SUMMER



THE MODERN COLLECTION LEATHER

COMPOSIZIONI / COMPOSITIONS / COMPOSITIONS / KOMPOSITIONEN

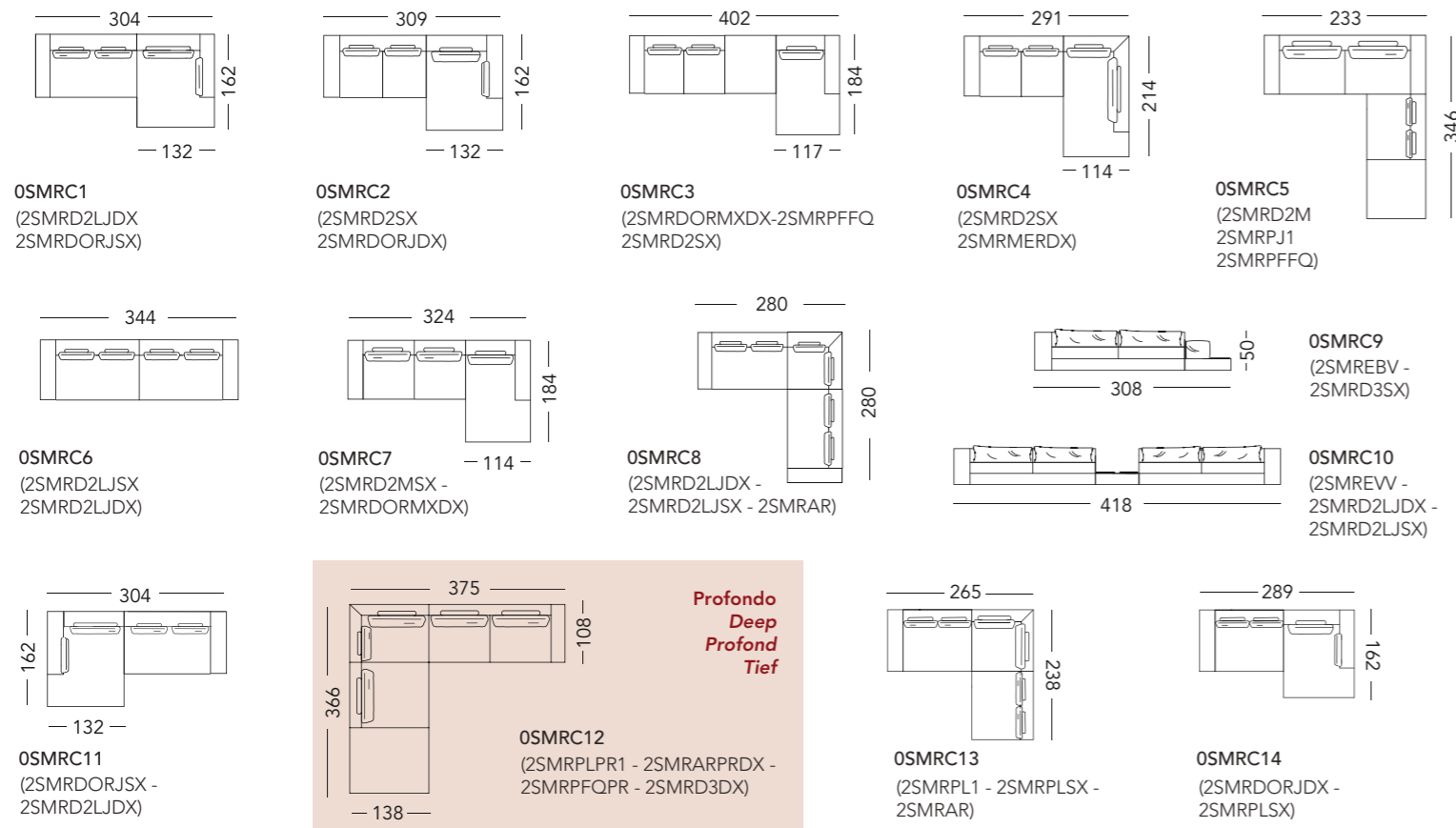

ELEMENTI / ELEMENTS / ELEMENTS / ELEMENTE

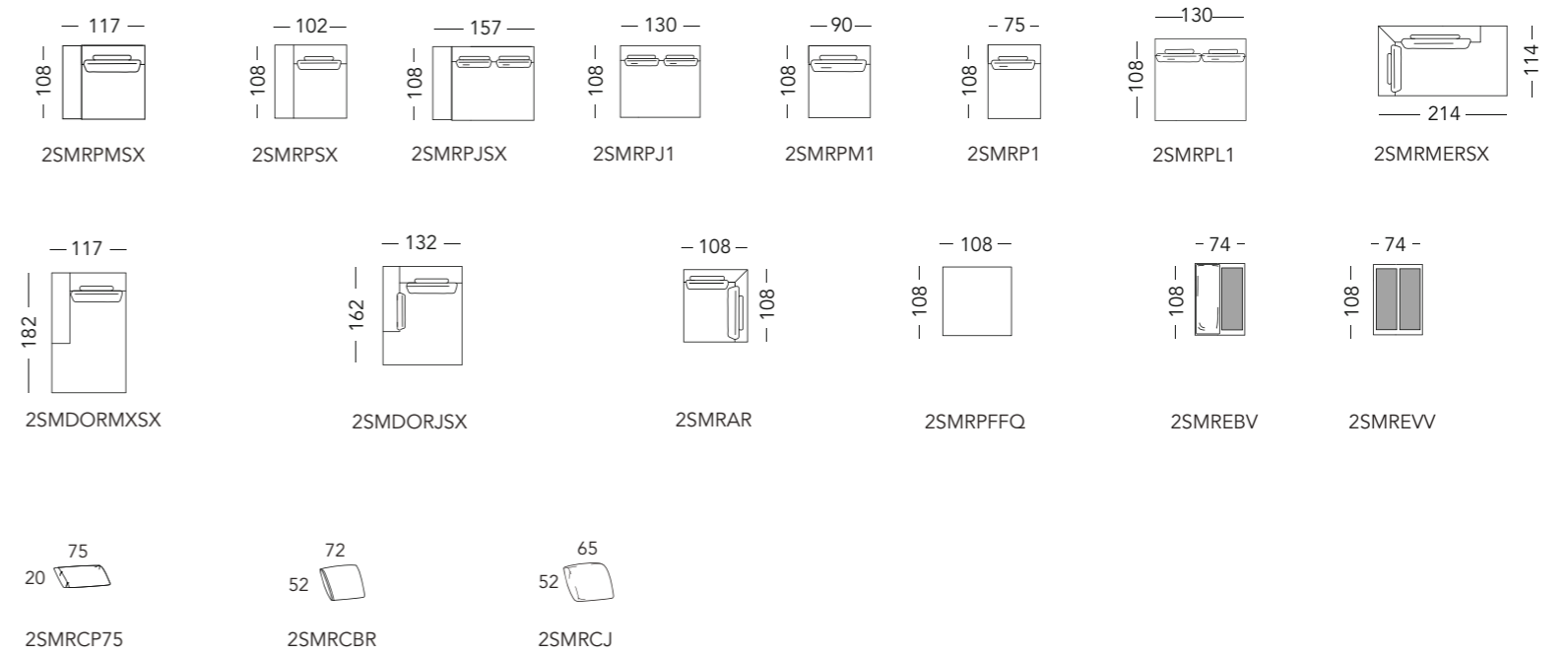

ELEMENTI / ELEMENTS / ELEMENTS / ELEMENTE

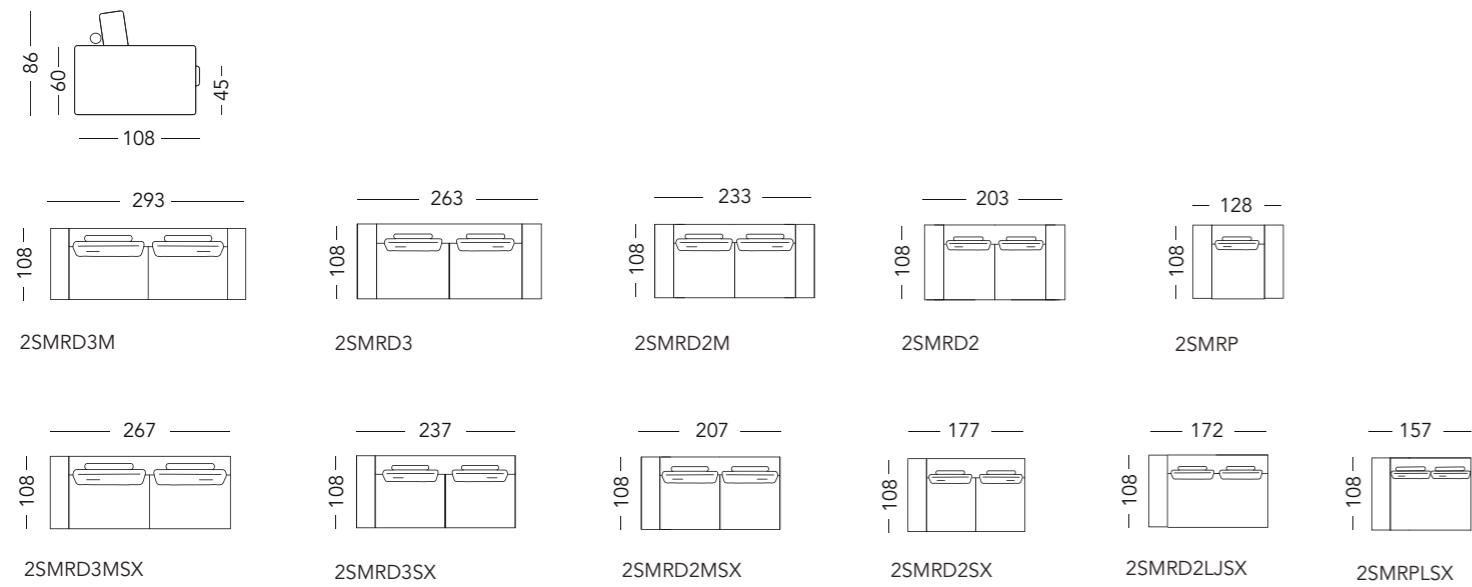

ELEMENTI / ELEMENTS / ELEMENTS / ELEMENTE

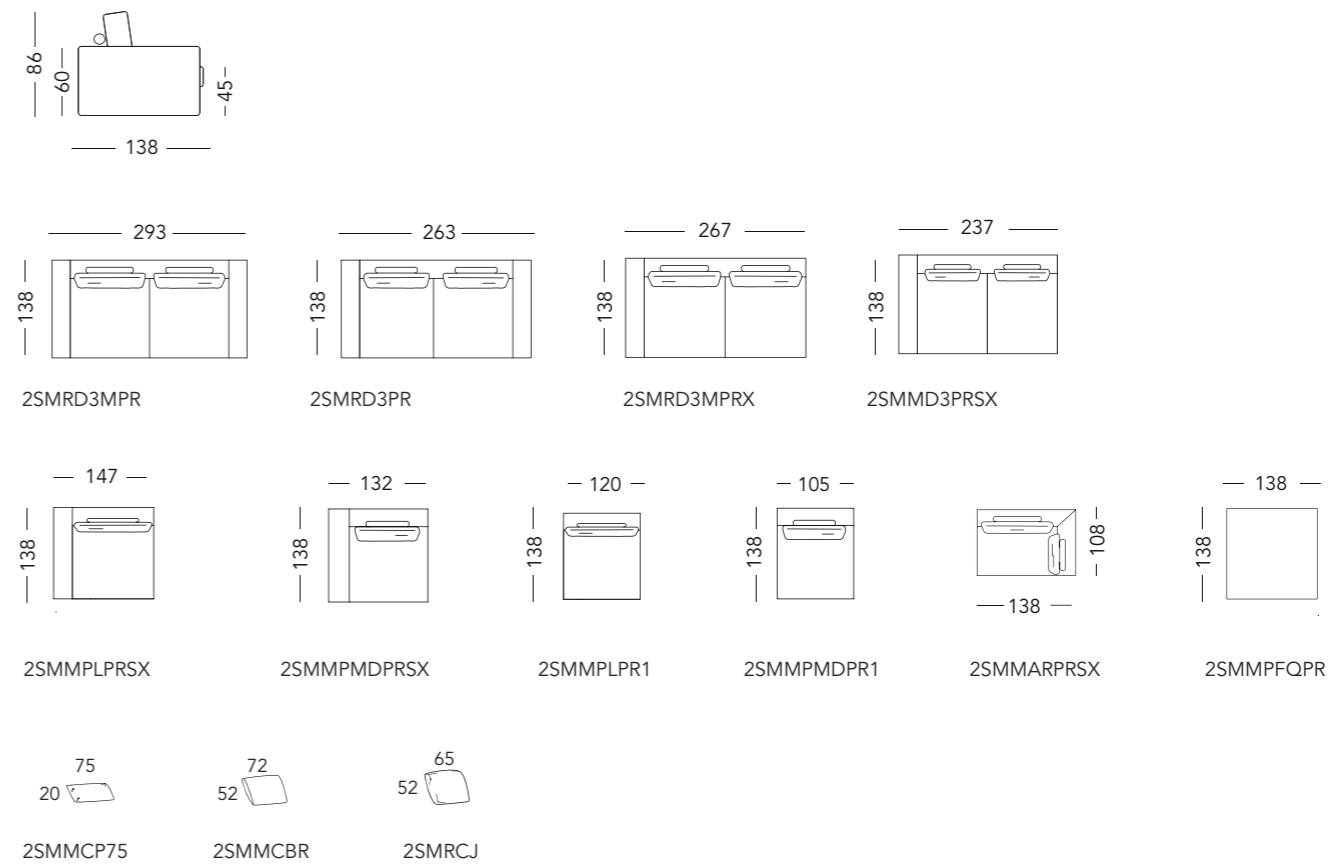

PROFONDO
Deep_Profond_Tief

THE MODERN COLLECTION LEATHER WILD



THE MODERN COLLECTION LEATHER

COMPOSIZIONI / COMPOSITIONS / COMPOSITIONS / KOMPOSITIONEN



ELEMENTI / ELEMENTS / ELEMENTS / ELEMENTE



CHAISE LONGUE / CHAISE LONGUE / CHAISE LONGUE / LIEGE

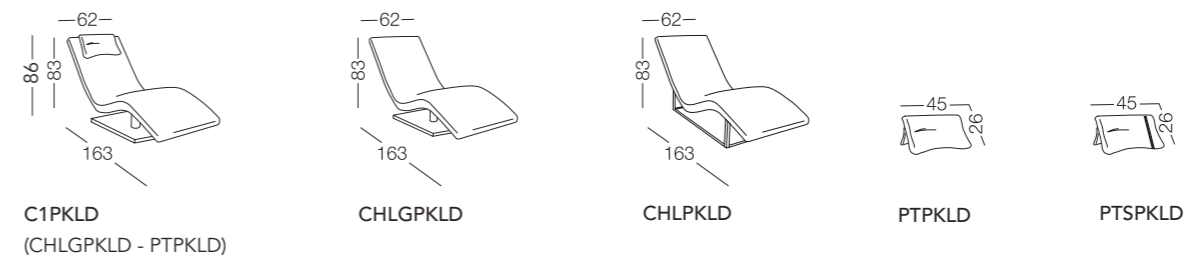

THE MODERN COLLECTION LEATHER

ARCADIA _ CHEOPE SQUARE _ CHESTER



THE MODERN COLLECTION LEATHER

ELEMENTI / ELEMENTS / ELEMENTS / ELEMENTE

ARCADIA

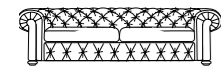
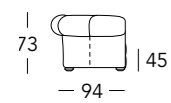

233
D3SPARD Swarovski

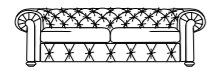

208
D2MSPARD Swarovski

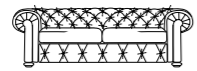

183
D2SPARD Swarovski

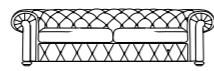

233
D3BPARD

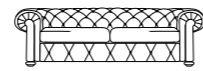

208
D2MPARD

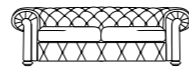

183
D2BPARD

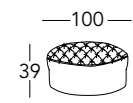

100
39
POUFFOSPARD Swarovski

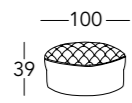

100
39
POUFFOBPARD

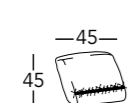

45
45
CQ4SPARD Swarovski

ELEMENTI / ELEMENTS / ELEMENTS / ELEMENTE

CHEOPE SQUARE

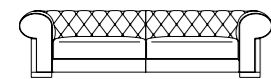
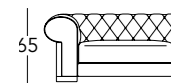

258
2CHSD3

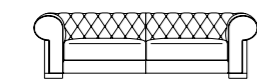
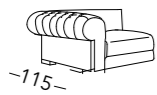

238
2CHSD2M

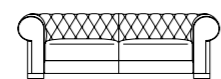

218
2CHSD2

ELEMENTI / ELEMENTS / ELEMENTS / ELEMENTE

CHESTER

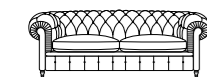
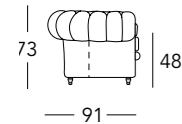

208

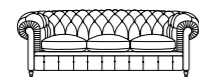

208

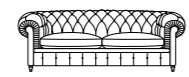

208

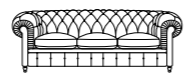

208

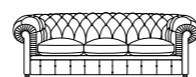

208

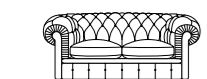

160

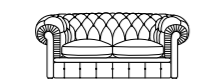

160

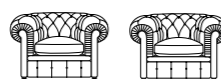

112

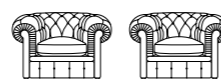

112

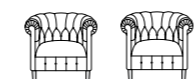

70

32PCHR (D2PCHR - D3PCHR)

332PCHR (D2PCHR - D33PCHR)

311PCHR (D3PCHR - PPCHR - PPCHR)

3311PCHR (D33PCHR - PPCHR - PPCHR)

311SPCHR (D33PCHR - PPCHR - PPCHR)

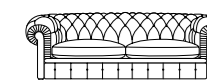

208
D3PCHR

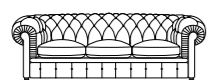

208
D33PCHR

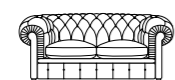

160
D2PCHR



112
PPCHR

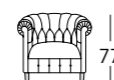

70
80
PSPCHR

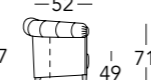

52
77
49
71
PNCPCR

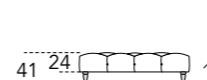

123
PNCPCR



70
POUFFPCHR

Mod. 99 Tessuto, fabric, tissu, Stoff

ELEMENTI / ELEMENTS / ELEMENTS / ELEMENTE

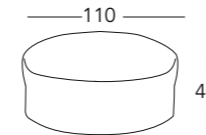

110
40
POUFFO99

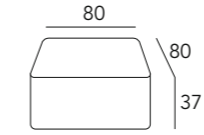

80
80
37
PFF8099

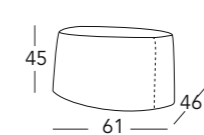

45
61
46
POUFFOV99

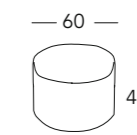

60
45
199POP

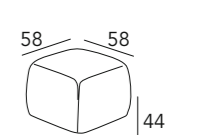

58
58
44
POUFFQB99

Mod. BABY Pelle, leather, cuir, Leder

ELEMENTI / ELEMENTS / ELEMENTS / ELEMENTE

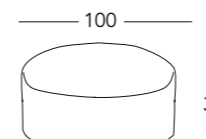

100
39
PFFTGPBBY

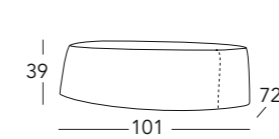

101
39
72
PFFVPBBY

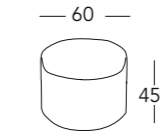

60
45
PFFTTPBBY

Mod. MORBIDOSO Tessuto, fabric, tissu, Stoff

ELEMENTI / ELEMENTS / ELEMENTS / ELEMENTE

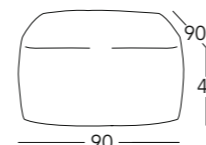

90
90
40
PFF90MRB

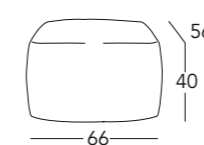

66
56
40
POUFFRMRB

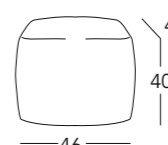

46
46
40
POUFFMRB

Mod. MORBIDOSO Pelle, leather, cuir, Leder

ELEMENTI / ELEMENTS / ELEMENTS / ELEMENTE

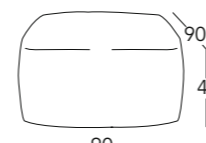

90
90
40
PFF90PMBP



66
56
40
POUFFRPMBP



46
46
40
POUFFPMBP



POUFFO99 - PFFTGPBBY



PFF8099



POUFFOV99



199POP



POUFFQB99



PFFVPBBY



PFFTTPBBY



PFF90MRB - PFF90PMBP



POUFFRMRB - POUFFRPMBP



POUFFMRB - POUFFPMBP

THE MODERN COLLECTION LEATHER

CUSCINI _ Mod. 99 _ Tessuto, fabric, tissu, Stoff

ELEMENTI / ELEMENTS / ELEMENTS / ELEMENTE

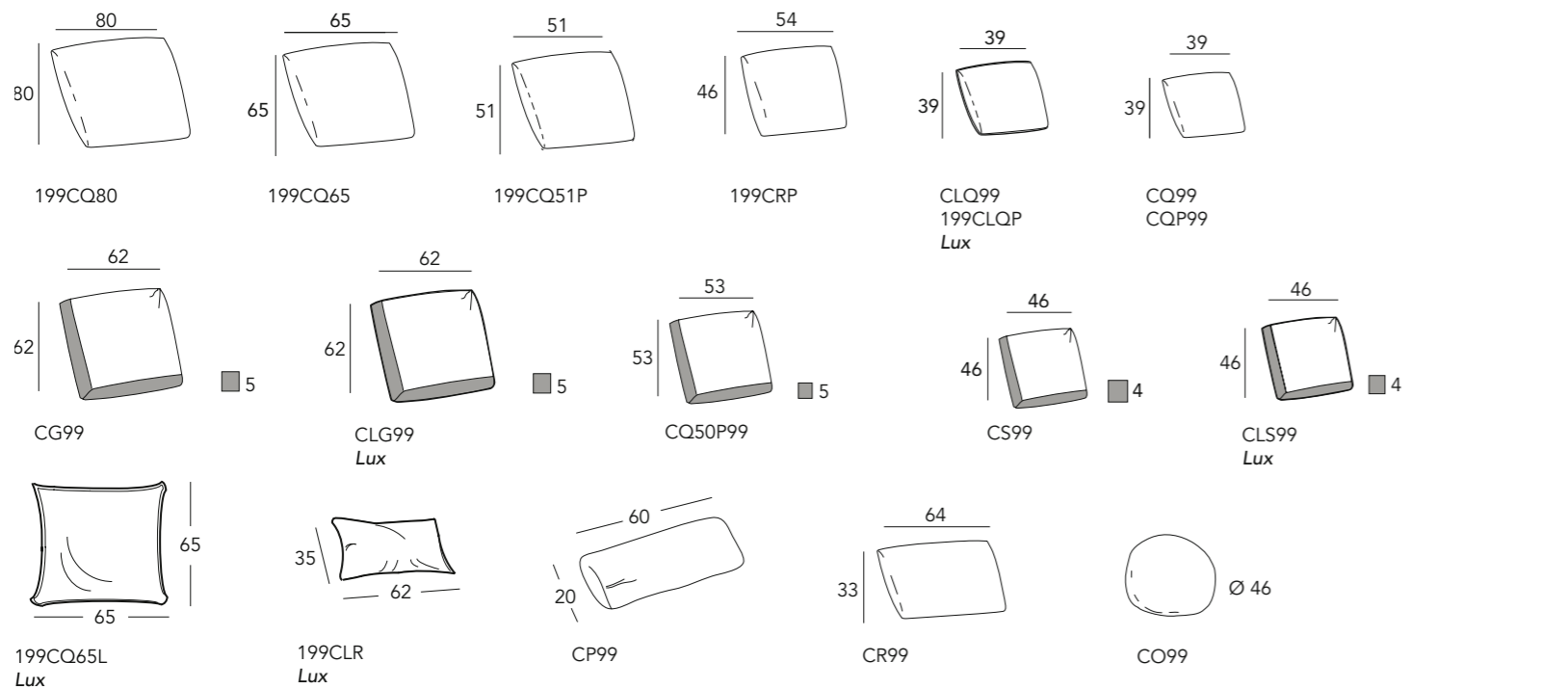

THE MODERN COLLECTION LEATHER

ELEMENTI / ELEMENTS / ELEMENTS / ELEMENTE

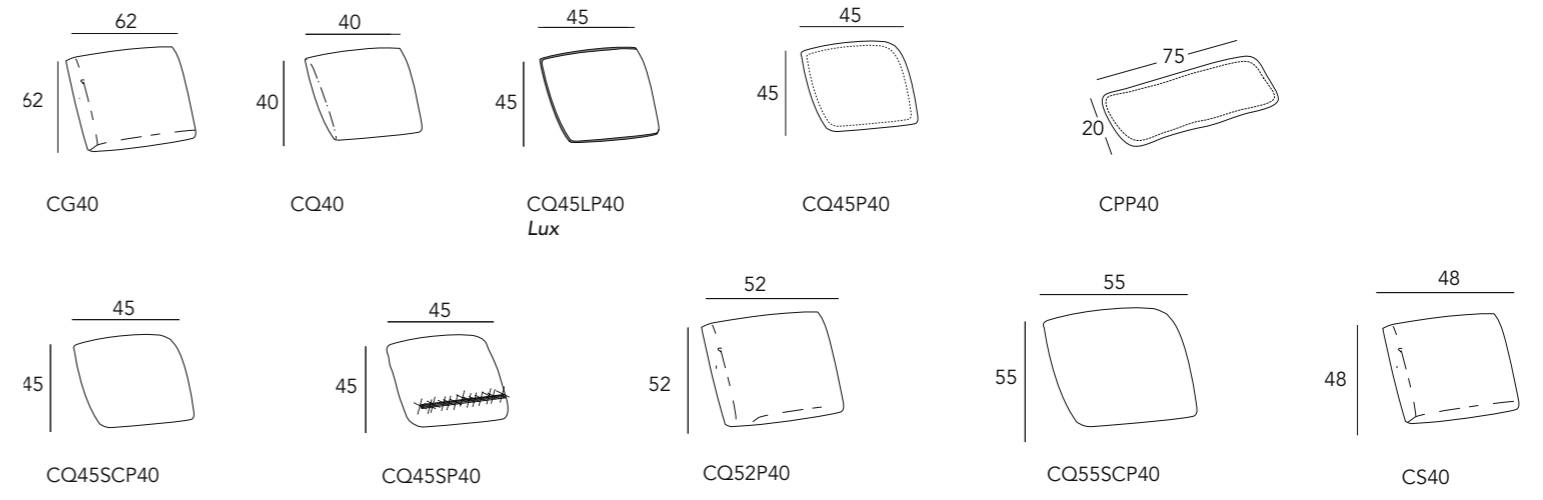

descrizioni tecniche

technical descriptions

alberta

AVENUE

Struttura portante in massello di legno. Cuscino di seduta in poliuretano espanso, cuscino di schienale in poliuretano espanso. Piedino realizzato in metallo cromato.

Main structure in solid wood. Seat cushion in polyurethane foam, backrest cushion in polyurethane foam. Chromium plated metal feet.

Carcasse principal en bois massif. Assise en polyuréthane expansé, dossier en polyuréthane expansé. Pied en métal chrome.

Struktur aus Massivholz (Schichtholz). Sitzkissen aus Polyurethanschaum, Rückenkissen aus Polyurethanschaum. Füße aus Metall verchromt.



Cod. BST



Cod. BLG



Cod. PD10152



Cod. PD10154

BLOW

Struttura portante in massello di legno. Cuscino di seduta in **piuma d'oca** e fibra di poliestere con inserto in poliuretano espanso, cuscino di schienale in **piuma d'oca** e fibra di poliestere. Due opzioni piedino entrambe in metallo cromato.

Main structure in solid wood. Seat cushion in polyurethane foam with upper part in **goose feathers** and polyester fiber, backrest cushion in **goose feathers** and polyester fiber. Two feet options both in chromium plated metal.

Carcasse principal en bois massif. Assise en polyuréthane expansé avec partie supérieur en **plumes d'oie** et fibre de polyester, dossier en **plumes d'oie** et fibre de polyester. Pieds disponibles en deux versions en métal chromé.

Tragstruktur aus Massivholz (Schichtholz). Sitzkissen aus Polyurethanschaum Oberteil aus **Gänsedaunen** und Polyesterfaser, Rückenkissen aus **Gänsedaunen** und Polyesterfaser. Zwei Füße Optionen beiden aus Metall verchromt

BROADWAY

Struttura portante in massello di legno. Cuscino di schienale in **mollapiuma** rivestito con fodera di cotone (oppure in poliuretano espanso), cuscino di seduta in poliuretano espanso. Piedino realizzato in metallo cromato oppure in legno finitura moka.

Main structure in solid wood. Seat cushion in polyurethane foam, backrest cushion in **down polyester** covered with cotton lining (or in polyurethane foam). Chromium plated metal feet or wooden feet moka finishing.

Carcasse principal en bois massif. Assise en polyuréthane expansé, dossier en **mollapiuma** sous housse de coton (ou en polyuréthane expansé). Pied en métal chrome ou en bois finition moka.

Tragstruktur aus Massivholz (Schichtholz). Sitzkissen aus Polyurethanschaum, Rückenkissen aus **Daunengemisch** im Baumwoll-Inlett (oder aus Polyurethanschaum). Füße aus Metall verchromt oder Holz mokkafarbig.



Cod. 159



Cod. 265

CALIFORNIA

Struttura portante in massello di legno. Cuscino di seduta in poliuretano espanso, cuscino di schienale in **piuma d'oca** e fibre di poliestere rivestito con fodera di cotone.

Main structure in solid wood. Seat cushion in polyurethane foam, backrest cushion in **goose feathers** and polyester fibre covered with cotton.

Structure principal en bois massif. Assise en polyuréthane expansé, dossier en **plumes d'oie** et fibre de polyester sous housse de coton.

Tragstruktur aus Massivholz. Sitzkissen aus Polyurethanschaum, Rückenkissen aus **Gänsedaunen** und Polyester-Fasern im Baumwoll-Inlett.



Cod. BST



Cod. BLG



CHORUS

Struttura portante in massello di legno. Cuscino di seduta in **piuma d'oca** e fibra di poliestere con inserto in poliuretano espanso, cuscino di schienale in **piuma d'oca** e fibra di poliestere.

*Main structure in solid wood. Seat cushion in polyurethane foam with upper part in **goose feathers** and polyester fibre, backrest cushion in **goose feathers** and polyester fiber.*

*Carcasse principal en bois massif. Assise en polyuréthane expansé avec partie supérieur en **plumes d'oie** et fibre de polyester, dossier en **plumes d'oie** et fibre de polyester.*

*Tragstruktur aus Massivholz (Schichtholz). Sitzkissen aus Polyurethanschaum Oberteil aus **Gänsedaunen** und Polyesterfaser, Rückenkissen aus **Gänsedaunen** und Polyesterfaser.*

DALLAS

Struttura portante in massello di legno. Cuscino di seduta in poliuretano espanso con imbottitura superiore in **piuma d'oca** e fibra di poliestere rivestito con fodera di cotone; cuscino di schienale in **particelle di lattice** e fibra di poliestere rivestito con fodera di cotone. Piedino in alluminio lucido.

*Main structure in solid wood. Seat cushion in polyurethane foam with upper part with **goose feathers** and polyester fiber covered with cotton covers; backrest cushion in **latex** and polyester fiber covered with cotton covers. Aluminum glossy feet.*

*Structure principal en bois massif. Coussin d'assise en polyuréthane expansé, partie supérieure en **plumes d'oie** et fibre de polyester sous housse de coton; coussin de dossier en **latex** et fibre de polyester sous housse de coton. Pieds en aluminium brillant.*

*Tragstruktur aus Massivholz. Sitzkissen aus Polyurethanschaum Oberteil aus **Gänsedaunen** und Polyesterfasen, Abgedeckt mit Baumwolle; Rückenkissen aus **Latexpartikeln** und Polyesterfasen, Abgedeckt mit Baumwolle. Füße aus poliert Aluminium.*



Cod. 183



Cod. 480

NEWPORT

Struttura portante in massello di legno. Cuscino di seduta in poliuretano espanso con imbottitura superiore in **piuma d'oca** e fibra di poliestere rivestito con fodera di cotone; cuscino di schienale in **piuma d'oca** e fibra di poliestere rivestito con fodera di cotone.

*Main structure in solid wood. Seat cushion in polyurethane foam with upper part with **goose feathers** and polyester fiber covered with cotton covers; backrest cushion in **goose feathers** and polyester fiber covered with cotton covers.*

*Structure principal en bois massif. Coussin d'assise en polyuréthane expansé, partie supérieure en **plumes d'oie** et fibre de polyester sous housse de coton; coussin de dossier en **plumes d'oie** et fibre de polyester sous housse de coton.*

*Tragstruktur aus Massivholz. Sitzkissen aus Polyurethanschaum Oberteil aus **Gänsedaunen** und Polyesterfasen, Abgedeckt mit Baumwolle; Rückenkissen aus **Gänsedaunen** und Polyesterfasen, Abgedeckt mit Baumwolle.*



Base



Cod. PD10152

RALPH

Struttura portante in massello di legno. Cuscino di seduta in poliuretano espanso, cuscino di schienale in **piuma d'oca** e particelle di poliuretano espanso. Basamento cromato oppure piedino in metallo cromato.

*Main structure in solid wood. Seat cushion in polyurethane foam, backrest cushion in **goose feathers** and polyurethane chips. Chromium plated metal base or feet.*

*Carcasse principal en bois massif. Assise en polyuréthane expansé, dossier en **plumes d'oie** et particules de polyuréthane expansé. Piètement en métal chrome ou pieds en métal chrome.*

*Tragstruktur aus Massivholz (Schichtholz). Sitzkissen aus Polyurethanschaum, Rückenkissen aus **Gänsedaunen** und Polyurethanschaum-Teilchen. Verchromte Metall Basis oder Füße.*



LUNA

Struttura portante in massello di legno. Cuscino di seduta in poliuretano espanso, cuscino di schienale in **piuma d'oca** e fibra di poliestere rivestito con fodera di cotone. Piedino realizzato in metallo cromato.

*Main structure in solid wood. Seat cushion in polyurethane foam, backrest cushion in **goose feathers** and polyester fiber covered with cotton covers. Chromium plated metal feet.*

*Carcasse principal en bois massif. Assise en polyuréthane expansé, dossier en **plumes d'oie** et fibre de polyester sous housse de coton. Pied en métal chrome.*

*Struktur aus Massivholz (Schichtholz). Sitzkissen aus Polyurethanschaum, Rückenkissen aus **Gänsedaunen** und Polyesterfasen, Abgedeckt mit Baumwolle. Füße aus Metall verchromt.*



MANHATTAN

Struttura portante in massello di legno. Cuscino di schienale in **mollapiuma** rivestito con fodera di cotone (oppure in poliuretano espanso), cuscino di seduta in poliuretano espanso. Piedino realizzato in metallo cromato oppure in legno finitura moka.

*Main structure in solid wood. Seat cushion in polyurethane foam, backrest cushion in **down polyester** covered with cotton lining (or in polyurethane foam). Chromium plated metal feet or wooden feet moka finishing.*

*Carcasse principal en bois massif. Assise en polyuréthane expansé, dossier en **mollapiuma** sous housse de coton (ou en polyuréthane expansé). Pied en métal chrome ou en bois finition moka.*

*Tragstruktur aus Massivholz (Schichtholz). Sitzkissen aus Polyurethanschaum, Rückenkissen aus **Daunengemisch** im Baumwoll-Inlett (oder aus Polyurethanschaum). Füße aus Metall verchromt oder Holz mokkafarbig.*



Cod. 158



Cod. 241

RIVER

Struttura portante in massello di legno. Cuscino di seduta in poliuretano espanso, cuscino di schienale in **piuma d'oca e particelle di lattice** con inserto in poliuretano espanso.

*Main structure in solid wood. Seat cushion in polyurethane foam, backrest cushion in **goose feather and chips of latex** with internal padding in polyurethane foam.*

*Structure principal en bois massif. Coussin d'assise en polyuréthane expansé, coussin de dossier en polyuréthane expansé avec partie supérieur en **plumes d'oie et latex**.*

*Tragstruktur aus Massivholz. Sitzkissen aus Polyurethanschaum, Rückenkissen aus Polyurethanschaum Oberteil aus **Gänsedaunen und Latexpartikeln**.*



STELLA _ MOON

Struttura portante in massello di legno. Cuscino schienale in **particelle di lattice** e fibra di poliestere rivestito con fodera di cotone, cuscino di seduta in poliuretano espanso con imbottitura superiore in **piuma d'oca** e fibra di poliestere rivestito con fodera di cotone. Meccanismo schienale in metallo zincato, permette l'avanzamento dello schienale.

*Main structure in solid wood. Backrest cushion in **latex** and polyester fiber covered with cotton covers, seat cushion in polyurethane foam with upper part in **goose feathers** and polyester fiber covered with cotton covers. Backrest mechanism in galvanized metal.*

*Structure principal en bois massif. Coussin de dossier en **latex** et fibre de polyester sous housse de coton, coussin d'assise en polyuréthane expansé partie supérieure en **plumes d'oie** et fibre de polyester sous housse de coton. Mécanisme de dossier en métal galvanisé.*

*Tragstruktur aus Massivholz. Rückenkissen aus **Latexpartikeln** und Polyesterfasern mit Baumwolle Gewebe überzogen, Sitzkissen aus Polyurethanschaum aus **Gänsedaunen** und Polyesterfasern mit Baumwolle Gewebe überzogen. Rückenlehne Mechanismus aus verzinktem Metall.*

SUMMER

Struttura portante in massello di legno. Molleggio realizzato con molle di tipo **Nosag**. Cuscino di schienale in **piuma d'oca** e fibra di poliestere con inserto in poliuretano espanso rivestito con fodera di cotone, cuscino di seduta in **piuma d'oca** e fibra di poliestere con inserto in poliuretano espanso rivestito con fodera di cotone.

*Main structure in solid wood. Springing system through **Nosag** springs. Backrest cushion polyurethane foam with upper part in **goose feathers** and polyester fiber covered with cotton covers, seat cushion in polyurethane foam with upper part **goose feathers** and polyester fiber covered with cotton covers.*

*Carcasse principal en bois massif. Suspensions réalisé avec ressort **Nosag**. Coussin de dossier en polyuréthane expansé avec partie supérieur en **plumes d'oie** et fibre de polyester sous housse de coton, coussin d'assise en polyuréthane expansé et **plumes d'oie** et fibre de polyester et sous housse de coton.*

*Tragstruktur aus Massivholz. Federung bestehend aus **Nosag** Riemen. Rückenissen aus Polyurethanschaum Oberteil aus **Gänsedaunen** und Polyesterfaser, Abgedeckt mit Baumwolle; Sitzkissen Polyurethanschaum Oberteil aus **Gänsedaunen** und Polyesterfaser, Abgedeckt mit Baumwolle.*



Cod. PD10145 Cod. PD10146

WILD

Struttura portante in massello di legno. Cuscino di seduta in **piuma d'oca** e fibra di poliestere con inserto in poliuretano espanso, cuscino di schienale in **piuma d'oca** e fibra di poliestere. Piedino in metallo cromato oppure in legno finitura moka.

*Main structure in solid wood. Seat cushion in polyurethane foam with upper part in **goose feathers** and polyester fiber, backrest cushion in **goose feathers** and polyester fiber. Chromium plated metal feet or wooden feet moka finishing.*

*Carcasse principal en bois massif. Assise en polyuréthane expansé avec partie supérieur en **plumes d'oie** et fibre de polyester, dossier en **plumes d'oie** et fibre de polyester. Pieds en métal chrome ou en bois finition moka.*

*Tragstruktur aus Massivholz (Schichtholz). Sitzkissen aus Polyurethanschaum Oberteil aus **Gänsedaunen** und Polyesterfaser, Rückenissen aus **Gänsedaunen** und Polyesterfaser. Füße aus Metall verchromt oder aus Holz mokkafarbig.*

KALINDA

Kalinda.

Struttura portante in massello di legno. Imbottitura in poliuretano espanso e **memory foam**, poggiatesta in **piuma d'oca** e fibra di poliestere. Basamento cromato girevole oppure fisso.

*Main structure in solid wood. Padding in polyurethane foam and **memory foam**, headrest in **goose feathers** and polyester fiber. Chromium plated base swivel or fix.*

*Structure principal en bois massif. Rembourrage en polyuréthane expansé et **memory foam**, appuie-tête en **plumes d'oie** et fibre de polyester. Piétement en métal chrome fixe ou tournante.*

*Tragstruktur aus Massivholz (Schichtholz). Polsterung aus Polyurethanschaum und **Memory Foam**, Kopflehne aus **Gänsedaunen** und Polyesterfaser. Metall verchromt Basis drehbar oder fest.*



ARCADIA

Struttura portante in massello di legno. Struttura imbottita in poliuretano espanso, cuscino di seduta in poliuretano espanso.

Main structure in solid wood. Structure upholstered in polyurethane foam, seat cushion in polyurethane foam.

Structure principal en bois massif. Structure rembourre en polyuréthane expansé, coussin d'assise en polyuréthane expansé.

Tragstruktur aus Massivholz. Korpus aus Polyurethanschaum, Sitzkissen aus Polyurethanschaum.

CHEOPE SQUARE

Struttura portante in massello di legno. Struttura imbottita in poliuretano espanso, cuscino di seduta in **piuma d'oca** rivestito in tela di cotone.

*Main structure in solid wood. Structure upholstered in polyurethane foam, seat cushion in **goose feathers** covered with cotton.*

*Structure principal en bois massif. Structure rembourre en polyuréthane expansé, coussin d'assise en **plumes d'oie** sous housse de coton.*

*Tragstruktur aus Massivholz. Korpus aus Polyurethanschaum, Sitzkissen aus **Gänsedaunen** mit Baumwolle Abdeckungen.*



CHESTER

Struttura portante in massello di legno. Struttura imbottita in poliuretano espanso, cuscino di seduta in **piuma d'oca** rivestito in tela di cotone.

*Main structure in solid wood. Structure upholstered in polyurethane foam, seat cushion in **goose feathers** covered with cotton.*

*Structure principal en bois massif. Structure rembourre en polyuréthane expansé, coussin d'assise en **plumes d'oie** sous housse de coton.*

*Tragstruktur aus Massivholz. Korpus aus Polyurethanschaum, Sitzkissen aus **Gänsedaunen** mit Baumwolle Abdeckungen.*



COMPANY PROFILE

Il marchio ALBERTA da trent'anni rappresenta garanzia di qualità nella progettazione e nella produzione di divani e poltrone.

L'azienda opera nel trevigiano, nord - est Italia, dal cui sostrato culturale ha attinto sia la tradizione artigiana sia l'attitudine alla creatività ed al design. Nel corso della sua storia ha sviluppato nei diversi stabilimenti linee di imbottiti sempre rispondenti all'evoluzione del gusto nelle due divisioni base che raggruppano le collezioni in tessuto e quelle in pelle. L'esperienza nell'impiego di entrambi i materiali consente ad Alberta di essere altamente propositiva. L'obiettivo dell'azienda è offrire soluzioni originali di ottimo livello estetico, pratico e qualitativo nel rispetto dei principi dell'etica ambientale.

For thirty years the ALBERTA brand has been recognised as a guarantee of quality in the design and production of sofas and armchairs. The company is headquartered in the Province of Treviso in the north east of Italy and has taken both its tradition of fine craftwork and its passion for creativity and design from this stimulating and active land. In order to meet the needs of ever-changing tastes the company has developed and now manufactures an extensive range of products based on two basic divisions, their textile and leather furniture collections. The experience they have gained working with these materials enables Alberta to be proactive and continually develop new solutions. The company mission is to create original products which combine great looks with practicality and quality while ensuring the utmost respect for the environment.

Die Marke ALBERTA steht seit dreißig Jahren als Garantie für Qualität in der Entwicklung und Herstellung von Sofas und Sesseln. Das Unternehmen hat seinen Hauptsitz in der Provinz Treviso, im Nordosten Italiens. Angeregt von dieser Kultur und Landschaft schöpft Alberta sowohl aus der handwerklichen Tradition als auch aus der Begabung und Leidenschaft für Kreativität und Design. Im Laufe seiner Geschichte hat das Unternehmen in seinen verschiedenen Betrieben eine breite Palette von Polstermöbel entwickelt, die den Bedürfnissen der Kunden entgegenkommt. Dabei sind zwei grundlegende Richtungen entstanden: die Stoff- und die Lederkollektion. Die gewonnenen Erfahrungen in der Verwendung mit beiden Materialien ermöglicht Alberta sehr aktiv zu sein und ständig neue Lösungen zu entwickeln. Das Unternehmen hat sich zum Ziel gesetzt, originelle Lösungen mit hohen ästhetischen, praktischen und qualitativen Niveau anzubieten und gleichzeitig umweltfreundlich zu sein.

Le marque Alberta depuis 30 ans c'est une garantie de qualité dans la projection et fabrication de fauteuils et canapés. L'usine opère dans la province de Treviso, nord-est de l'Italie, et du substrat culturel de cette zone elle a pris soit la tradition artisanale soit la disposition à la créativité et au design. Au cours de l'histoire elle a développé dans les différents usines des lignes des canapés toujours correspondant à l'évolution du goût dans les deux collections en cuir et tissu. L'expérience dans l'utilisations des matériaux a permis à Alberta d'être bien propositiva avec ces collections. L'objectif de l'usine est offrir solutions originales de niveau esthétique, pratique et qualitatif excellent dans le respect des principes de l'éthique de l'ambiance.

La riproduzione totale o parziale è permessa esclusivamente su nostra autorizzazione. Le immagini e i disegni contenuti nel presente catalogo sono puramente rappresentativi di questo prodotto e possono subire variazioni e modifiche anche senza preavviso. Pertanto nella scelta degli articoli per la compilazione dell'ordine, fa fede solamente quanto contenuto nel listino in vigore.

Reproduction, total or partial, is allowed exclusively under licence from our company. The photographs and drawings in this catalogue are only a representation of products and may be varied and changed without notice.

When choosing article for your orders, only the details contained in the price-list in force should be considered.

La reproduction totale ou partielle est soumise exclusivement à notre autorisation. Les images et les dessins présents dans ce catalogue sont uniquement des représentations de ce produit et peuvent subir des variations et des modifications même sans prèavis.

Par conséquent, une fois les article choisis, lorsque vous remplirez le bon de commande, rêfèrez-vous au tarif en vigueur car il est le seul à faire foi.

Die Teilweise oder Gesamte Wiedergabe ist Ausschließlich mit unserer Erlaubnis gestattet. Hinweis: Alle in diesem Katalog enthaltenen Abbildungen sind unverbindlich; wir behaltenuns das Recht vor, änderungen oder Verbesserungen ohne Ankündigung durchzuführen.

Maßgeblich für die Auswahl der einzelnen zu bestellenden Produkte ist ausschließlich die jeweils gültige Verkaufspreisliste.

Photo: Fotorama - Renai&Renai

Design: arch. A. Tubia

Art direction: Ufficio Stile Alberta Pacific Furniture

Printed in Italy by:

alberta[®]
The first name in Italian sofas

Alberta Pacific Furniture SPA
Via Toniolo, 41
31028 Vazzola (TV) Italy
Tel. +39 0438 440440
Fax +39 0438 441555
email: alberta@alberta.it

www.alberta.it

alberta[®]
The first name in Italian sofas

| | |
|---------------|-----|
| AVENUE | 6 |
| BLOW | 14 |
| BROADWAY | 30 |
| CALIFORNIA | 38 |
| CHORUS | 44 |
| DALLAS | 50 |
| LUNA | 58 |
| MANHATTAN | 64 |
| NEWPORT | 74 |
| RALPH | 84 |
| RIVER | 92 |
| STELLA-MOON | 100 |
| SUMMER | 112 |
| WILD | 122 |
| KALINDA | 132 |
| ARCADIA | 140 |
| CHEOPE SQUARE | 146 |
| CHESTER | 152 |
| POUFF | 158 |
| CUSCINI | 170 |